



LOAD FEEDER FUSELESS DIRECT START,  
 AC 400V, SZ S00 0.28. . .0.4A,  
 DC 24V SCREW CONNECTION FOR BUSBAR SYSTEMS  
 60MM TYPE OF COORDINATION 2,  
 IQ = 150KA (ALSO FULFILLS TYPE OF COORDINATION 1)  
 1NO (CONTACTOR)

Allgemeine technische Daten:		
product brand name		SIRIUS
Product designation		non-fused load feeders 3RA2
Size of the load feeder		S00
Number of poles / for main current circuit		3
Installation altitude / at a height over sea level / maximum	m	2,000
Product function		
• short circuit protection		Yes
• overload protection		Yes
• phase disturbance recognition		Yes
Product component		
• trip indicator		No
• auxiliary switch		No
Product extension / auxiliary switch		Yes
Design of display / for switching status		Switch setting
Insulation voltage / with degree of pollution 3 / rated value	V	690
Impulse voltage resistance / rated value	kV	6
Protection class IP		
• on the front		IP20
Protection against electrical shock		finger-safe

<b>Shock resistance / according to IEC 60068-2-27</b>		6g / 11 ms
<b>maximum permissible voltage for safe isolation in networks with non-grounded star point</b>		
<b>Ambient temperature</b>	°C	
• during transport		-50 ... +80
• during storage		-50 ... 80
• during operating		-20 ... 60
<b>Manufacturer article number</b>		
• of the circuit-breakers included in the scope of supply		<a href="#">3RV2011-0EA10</a>
• of the contactor included in the scope of supply		<a href="#">3RT2015-1BB41</a>
• of the RS applied assembly kit		
• of the link module included in the scope of supply		<a href="#">3RA1921-1DA00</a>
• of the busbar adapter included in the scope of supply		<a href="#">8US1251-5DS10</a>
• of the RH applied assembly kit		

#### Hauptstromkreis:

<b>Operating current / rated value</b>	A	16
<b>Mechanical operating cycles as operating time / of the auxiliary contacts / typical</b>		30,000,000
<b>Derating factor for rated value of the operational current</b>		
<b>Operating voltage / rated value</b>	V	690
<b>Voltage type / for main circuit</b>		AC
<b>Frequency</b>		-
<b>Service power / at AC-3</b>	W	
• at 400 V / rated value		90
• at 500 V rated value		120
• at 690 V rated value		120
<b>Operating current / at AC-3 / at 400 V / rated value</b>	A	0.3
<b>Type of assignment</b>		2

#### Steuerstromkreis/ Ansteuerung:

<b>Voltage type / for auxiliary and control circuit</b>		DC
<b>Holding power / of the solenoid / for DC</b>	W	4

#### Hilfsstromkreis:

<b>Number of NC contacts / for auxiliary contacts</b>		0
<b>Number of NO contacts / for auxiliary contacts</b>		1
<b>Number of changeover contacts / for auxiliary contacts</b>		0

#### Schutz-/Überwachungsfunktion:

<b>Design of the overload circuit breaker</b>		thermal (bimetallic)
<b>Trip class</b>		CLASS 10

<b>Adjustable response current / of the current-dependent overload release</b>	A	0.28 ... 0.4
<b>Design of the short-circuit trip</b>		magnetic
<b>Conditional short-circuit current (I<sub>q</sub>)</b>		
• at 400 V / according to IEC 60947-4-1 / rated value	A	153,000
• at 500 V / according to IEC 60947-4-1 / rated value	A	100,000
• at 690 V according to IEC 60947-4-1 rated value		100,000
<b>Varification of suitability / ATEX</b>		Yes

#### Sicherheitsrelevante Kenngrößen:

<b>Proportion of dangerous failures</b>		
• with high demand rate / according to SN 31920	%	73
<b>B10 value / with high demand rate / according to SN 31920</b>		1,000,000

#### Einbau/ Befestigung/ Abmessungen:

<b>Mounting type</b>		for snapping onto 60 mm busbar systems
<b>mounting position</b>		vertical
<b>Depth</b>	mm	155.1
<b>Height</b>	mm	200
<b>Width</b>	mm	45
<b>Distance, to be maintained, to the ranks assembly</b>		
• upwards	mm	20
• forwards	mm	0
• sideways		0
• backwards		0
• downwards		30

#### Anschlüsse/ Klemmen:





<b>Arrangement of electrical connectors / for main current circuit</b>		from the top
<b>Design of the electrical connection</b>		
• for main current circuit		screw-type terminals
• for auxiliary and control current circuit		screw-type terminals
<b>Type of the connectable conductor cross-section for main contacts</b>		
• solid or multi-stranded		2x (0,75 ... 2,5 mm <sup>2</sup> ), 2x 4 mm <sup>2</sup>
• finely stranded		
• with conductor end processing		2x (0.5 ... 2.5 mm <sup>2</sup> )
<b>Type of the connectable conductor cross-section for auxiliary contacts</b>		
• solid or multi-stranded		2x (0,5 ... 1,5 mm <sup>2</sup> ), 2x (0,75 ... 2,5 mm <sup>2</sup> )
• finely stranded		
• with conductor end processing		2x (0.5 ... 1.5 mm <sup>2</sup> ), 2x (0.75 ... 2.5 mm <sup>2</sup> )

<b>Type of the connectable conductor cross-section / for AWG conductors</b>		
<ul style="list-style-type: none"> <li>• for main contacts</li> <li>• for auxiliary contacts</li> </ul>		2x (18 ... 14), 2x 12 2x (20 ... 16), 2x (18 ... 14)
<b>Tightening torque / for main contacts</b>		
<ul style="list-style-type: none"> <li>• with screw-type terminals</li> </ul>	N·m	0.8 ... 1.2
<b>Design of the thread of the connection screw for main contacts</b>		
M3	M3	
<b>Tightening torque / for auxiliary contacts</b>		
<ul style="list-style-type: none"> <li>• with screw-type terminals</li> </ul>	N·m	0.8 ... 1.2
<b>Design of the thread of the connection screw of the auxiliary and control pins</b>		
M3	M3	
<b>Dimension de la tête de tournevis</b>		Pozidriv 2

#### UL/CSA Bemessungsdaten:

<b>yielded mechanical performance [hp] / for three-phase squirrel cage motors</b>		
<ul style="list-style-type: none"> <li>• at 460/480 V rated value</li> <li>• at 575/600 V rated value</li> </ul>		
<b>Full-load current (FLA) / for 3-phase motor</b>		
<ul style="list-style-type: none"> <li>• at 480 V / rated value</li> </ul>	A	0.4

#### Approbationen/ Zertifikate:

General Product Approval	For use in hazardous locations	Declaration of Conformity
 CSA	 UL	 EG-Konf.
 EAC	 ATEX	

#### Test Certificates

[Special Test Certificate](#)     
 [Type Test Certificates/Test Report](#)

#### Shipping Approval



#### other

[Declaration of Conformity](#)     
 [other](#)     
 [Environmental Confirmations](#)

#### Weitere Informationen:

Information- and Downloadcenter (Kataloge, Broschüren,...)

<http://www.siemens.de/industrial-controls/catalogs>

Industry Mall (Online-Bestellsystem)

<http://www.siemens.de/industrial-controls/mall>

CAx-Online-Generator

<http://www.siemens.com/cax>

Service&Support (Handbücher, Betriebsanleitungen, Zertifikate, Kennlinien, FAQs,...)

<http://support.automation.siemens.com/WW/view/de/3RA2110-0ED15-1BB4/all>

Bilddatenbank (Produktfotos, 2D-Maßzeichnungen, 3D-Modelle, Geräteschaltpläne, ...)

[http://www.automation.siemens.com/bilddb/cax\\_de.aspx?mlfb=3RA2110-0ED15-1BB4](http://www.automation.siemens.com/bilddb/cax_de.aspx?mlfb=3RA2110-0ED15-1BB4)

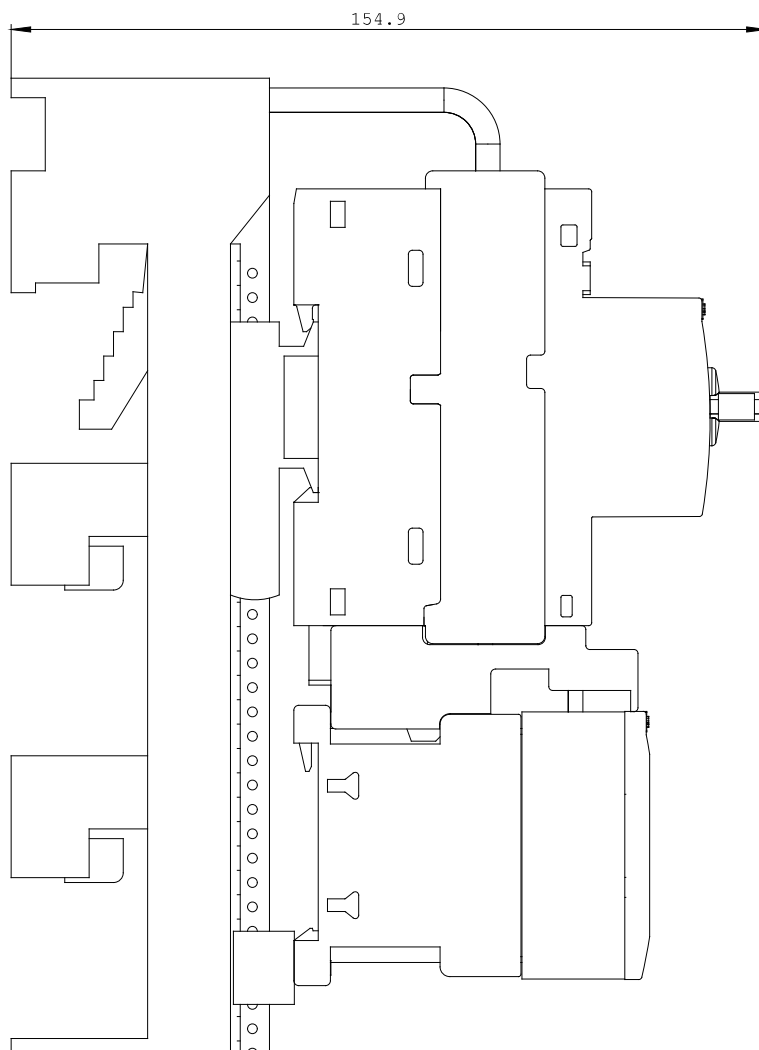
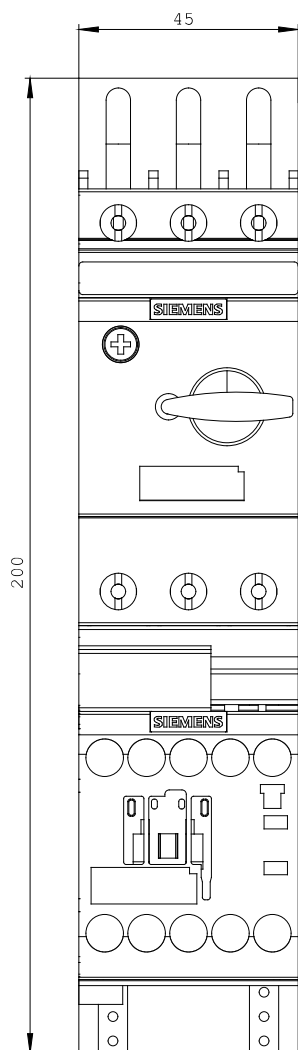

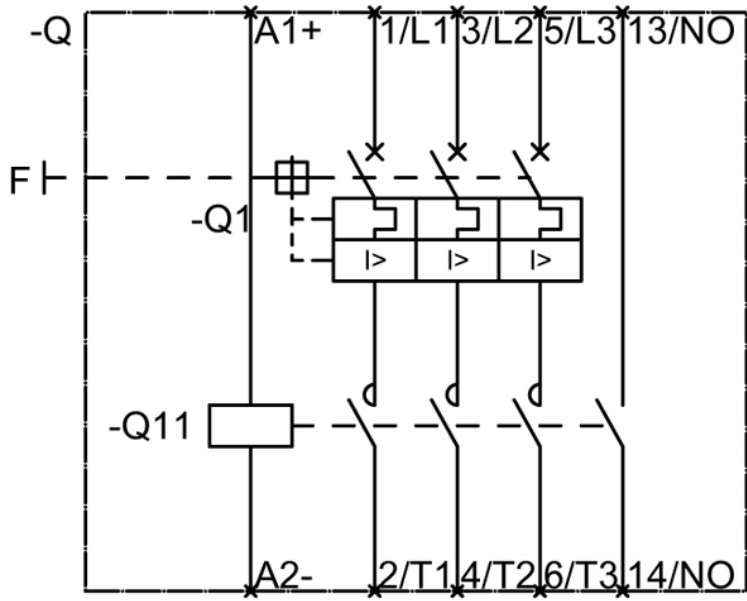

letzte Änderung:

Aug 4, 2014