



LOAD FEEDER FUSELESS DIRECT START,
 AC 400V, SZ S00 1.4. . .2A,
 DC 24V SPRING-LOADED CONNECTION FOR BUSBAR
 SYSTEMS 60MM TYPE OF COORDINATION 2,
 IQ = 150KA (ALSO FULFILLS TYPE OF COORDINATION 1)
 1NO (CONTACTOR)

Allgemeine technische Daten:

product brand name		SIRIUS
Product designation		non-fused load feeders 3RA2
Size of the load feeder		S00
Number of poles / for main current circuit		3
Installation altitude / at a height over sea level / maximum	m	2,000
Product function		
• short circuit protection		Yes
• overload protection		Yes
• phase disturbance recognition		Yes
Product component		
• trip indicator		No
• auxiliary switch		No
Product extension / auxiliary switch		Yes
Design of display / for switching status		Switch setting
Insulation voltage / with degree of pollution 3 / rated value	V	690
Impulse voltage resistance / rated value	kV	6
Protection class IP		
• on the front		IP20
Protection against electrical shock		finger-safe

Shock resistance / according to IEC 60068-2-27		6g / 11 ms
maximum permissible voltage for safe isolation in networks with non-grounded star point		
Ambient temperature	°C	
• during transport		-50 ... +80
• during storage		-50 ... 80
• during operating		-20 ... 60
Manufacturer article number		
• of the circuit-breakers included in the scope of supply		3RV2011-1BA20
• of the contactor included in the scope of supply		3RT2015-2BB41
• of the RS applied assembly kit		
• of the link module included in the scope of supply		3RA2911-2AA00
• of the busbar adapter included in the scope of supply		8US1251-5DT11
• of the RH applied assembly kit		

Hauptstromkreis:

Operating current / rated value	A	16
Mechanical operating cycles as operating time / of the auxiliary contacts / typical		30,000,000
Derating factor for rated value of the operational current		
Operating voltage / rated value	V	690
Voltage type / for main circuit		AC
Frequency		-
Service power / at AC-3	W	
• at 400 V / rated value		750
• at 500 V rated value		750
• at 690 V rated value		1,100
Operating current / at AC-3 / at 400 V / rated value	A	1.9
Type of assignment		2

Steuerstromkreis/ Ansteuerung:

Voltage type / for auxiliary and control circuit		DC
Holding power / of the solenoid / for DC	W	4

Hilfsstromkreis:

Number of NC contacts / for auxiliary contacts		0
Number of NO contacts / for auxiliary contacts		1
Number of changeover contacts / for auxiliary contacts		0

Schutz-/Überwachungsfunktion:

Design of the overload circuit breaker		thermal (bimetallic)
Trip class		CLASS 10

Adjustable response current / of the current-dependent overload release	A	1.4 ... 2
Design of the short-circuit trip		magnetic
Conditional short-circuit current (I_q)		
• at 400 V / according to IEC 60947-4-1 / rated value	A	153,000
• at 500 V / according to IEC 60947-4-1 / rated value	A	100,000
• at 690 V according to IEC 60947-4-1 rated value		10,000
Varification of suitability / ATEX		Yes

Sicherheitsrelevante Kenngrößen:

Proportion of dangerous failures		
• with high demand rate / according to SN 31920	%	73
B10 value / with high demand rate / according to SN 31920		1,000,000

Einbau/ Befestigung/ Abmessungen:

Mounting type		for snapping onto 60 mm busbar systems
mounting position		vertical
Depth	mm	155.1
Height	mm	260
Width	mm	45
Distance, to be maintained, to the ranks assembly		
• upwards	mm	20
• forwards	mm	0
• sideways		0
• backwards		0
• downwards		30

Anschlüsse/ Klemmen:







Arrangement of electrical connectors / for main current circuit		from front
Design of the electrical connection		
• for main current circuit		spring-loaded terminals
• for auxiliary and control current circuit		spring-loaded terminals
Type of the connectable conductor cross-section for main contacts		
• solid or multi-stranded		2x (0,5 ... 4 mm ²)
• finely stranded		
• with conductor end processing		2x (0.5 ... 1.5 mm ²), 2x (0.75 ... 2.5 mm ²)
• without conductor final cutting		2x (0.5 ... 2.5 mm ²)
Type of the connectable conductor cross-section for auxiliary contacts		
• solid or multi-stranded		2x (0,5 ... 4 mm ²)
• finely stranded		

<ul style="list-style-type: none"> with conductor end processing without conductor final cutting 	2x (0.5 ... 2.5 mm ²)
Type of the connectable conductor cross-section / for AWG conductors <ul style="list-style-type: none"> for main contacts for auxiliary contacts 	2x (20 ... 12) 2x (20 ... 16), 2x (18 ... 14)
Design of the thread of the connection screw for main contacts	
Design of the thread of the connection screw of the auxiliary and control pins	

UL/CSA Bemessungsdaten:

yielded mechanical performance [hp] / for three-phase squirrel cage motors <ul style="list-style-type: none"> at 460/480 V rated value at 575/600 V rated value 	0.75 1
Full-load current (FLA) / for 3-phase motor <ul style="list-style-type: none"> at 480 V / rated value 	A 2

Approbationen/ Zertifikate:

General Product Approval	For use in hazardous locations	Declaration of Conformity
		
		

Test Certificates

[Special Test Certificate](#) [Type Test Certificates/Test Report](#)

Shipping Approval



other

[Declaration of Conformity](#) [other](#) [Environmental Confirmations](#)

Weitere Informationen:

Information- and Downloadcenter (Kataloge, Broschüren,...)

<http://www.siemens.de/industrial-controls/catalogs>

Industry Mall (Online-Bestellsystem)

<http://www.siemens.de/industrial-controls/mall>

CAx-Online-Generator

<http://www.siemens.com/cax>

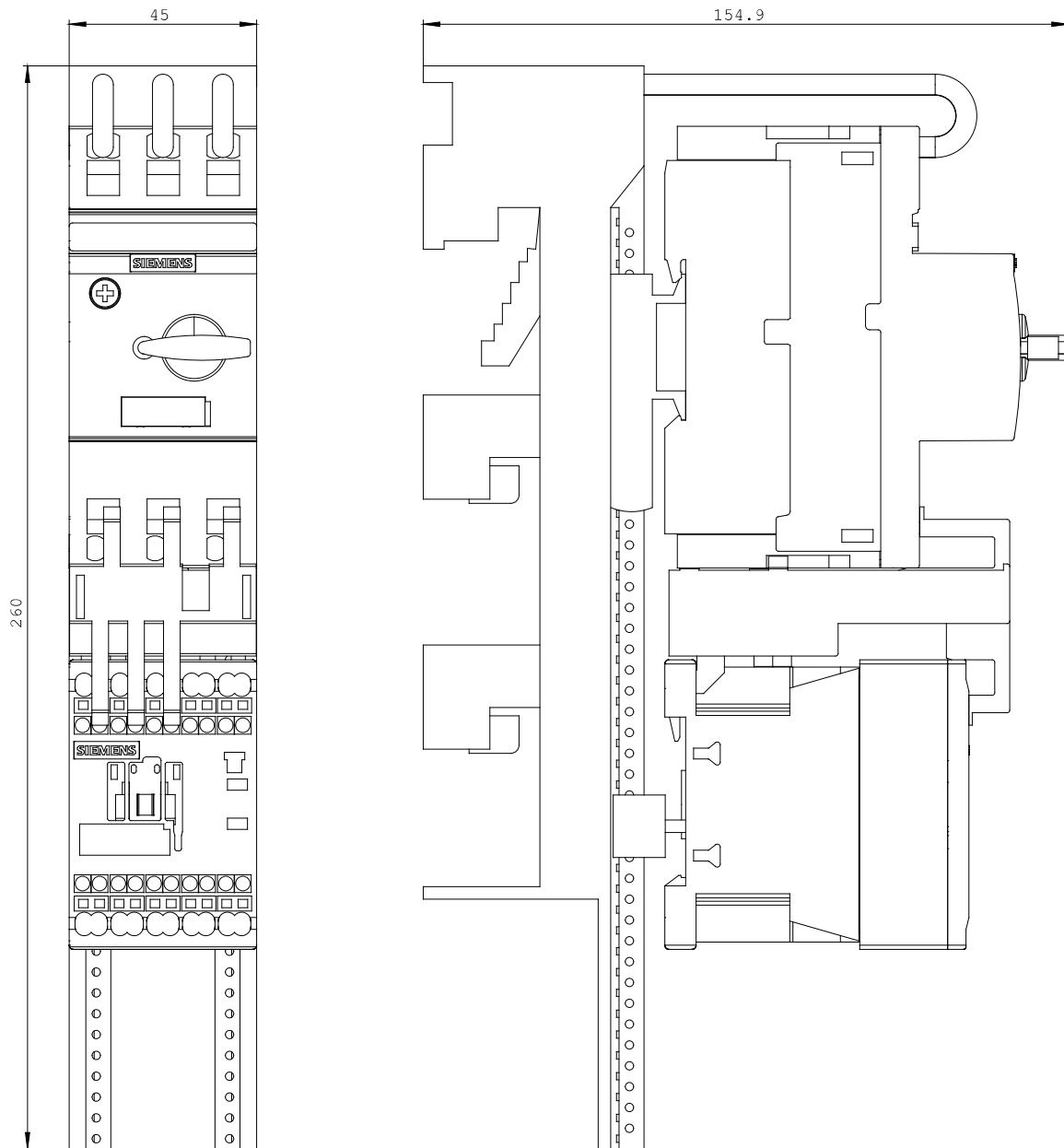

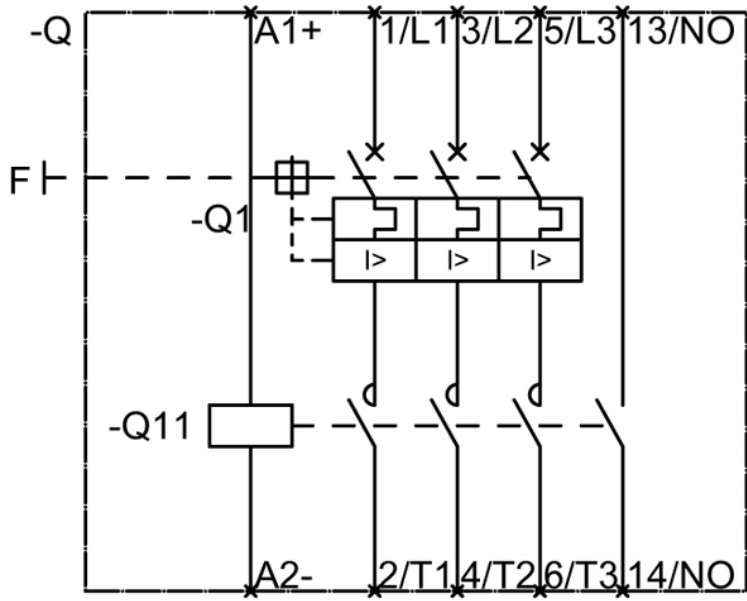

letzte Änderung:

Aug 4, 2014