



LOAD FEEDER FUSELESS DIRECT START,
 AC 400V, SZ S0, 5,5. . .8A,
 DC 24V SCREW CONNECTION FOR RAIL-MOUNTING,
 TYPE OF COORDINATION 2,
 IQ = 150KA (ALSO FULFILLS TYPE OF COORDINATION 1)
 1NO+1NC (CONTACTOR)

Allgemeine technische Daten:

product brand name		SIRIUS
Product designation		non-fused load feeders 3RA2
Size of the load feeder		S0
Number of poles / for main current circuit		3
Installation altitude / at a height over sea level / maximum	m	2,000
Product function		
• short circuit protection		Yes
• overload protection		Yes
• phase disturbance recognition		Yes
Product component		
• trip indicator		No
• auxiliary switch		No
Product extension / auxiliary switch		Yes
Design of display / for switching status		Switch setting
Insulation voltage / with degree of pollution 3 / rated value	V	690
Impulse voltage resistance / rated value	kV	6
Protection class IP		
• on the front		IP20
Protection against electrical shock		finger-safe

Shock resistance / according to IEC 60068-2-27		6g / 11 ms
maximum permissible voltage for safe isolation in networks with non-grounded star point		
Ambient temperature	°C	
• during transport		-50 ... +80
• during storage		-50 ... 80
• during operating		-20 ... 60
Manufacturer article number		
• of the circuit-breakers included in the scope of supply		3RV2021-1HA10
• of the contactor included in the scope of supply		3RT2024-1BB40
• of the RS applied assembly kit		
• of the link module included in the scope of supply		3RA2921-1AA00
• of the busbar adapter included in the scope of supply		
• of the RH applied assembly kit		

Hauptstromkreis:

Operating current / rated value	A	32
Mechanical operating cycles as operating time / of the auxiliary contacts / typical		10,000,000
Derating factor for rated value of the operational current		
Operating voltage / rated value	V	690
Voltage type / for main circuit		AC
Frequency		-
Service power / at AC-3	W	
• at 400 V / rated value		3,000
• at 500 V rated value		4,000
• at 690 V rated value		5,500
Operating current / at AC-3 / at 400 V / rated value	A	6.5
Type of assignment		2

Steuerstromkreis/ Ansteuerung:

Voltage type / for auxiliary and control circuit		DC
Holding power / of the solenoid / for DC	W	5.9

Hilfsstromkreis:

Number of NC contacts / for auxiliary contacts		1
Number of NO contacts / for auxiliary contacts		1
Number of changeover contacts / for auxiliary contacts		0

Schutz-/Überwachungsfunktion:

Design of the overload circuit breaker		thermal (bimetallic)
Trip class		CLASS 10

Adjustable response current / of the current-dependent overload release	A	5.5 ... 8
Design of the short-circuit trip		magnetic
Conditional short-circuit current (I_q)		
• at 400 V / according to IEC 60947-4-1 / rated value	A	153,000
• at 500 V / according to IEC 60947-4-1 / rated value	A	42,000
• at 690 V according to IEC 60947-4-1 rated value		4,000
Varification of suitability / ATEX		Yes

Sicherheitsrelevante Kenngrößen:

Proportion of dangerous failures		
• with high demand rate / according to SN 31920	%	73
B10 value / with high demand rate / according to SN 31920		1,000,000

Einbau/ Befestigung/ Abmessungen:

Mounting type		screw and snap-on mounting onto 35 mm standard mounting rail
mounting position		vertical
Depth	mm	107
Height	mm	193.1
Width	mm	45
Distance, to be maintained, to the ranks assembly		
• upwards	mm	30
• forwards	mm	10
• sideways		0
• backwards		0
• downwards		30

Anschlüsse/ Klemmen:





Arrangement of electrical connectors / for main current circuit		from the top
Design of the electrical connection		
• for main current circuit		screw-type terminals
• for auxiliary and control current circuit		screw-type terminals
Type of the connectable conductor cross-section for main contacts		
• solid or multi-stranded		2x (1 ... 2,5 mm ²), 2x (2,5 ... 10 mm ²)
• finely stranded		
• with conductor end processing		2x (1 ... 2.5 mm ²), 2x (2.5 ... 6 mm ²), 1x 10 mm ²
Type of the connectable conductor cross-section for auxiliary contacts		
• solid or multi-stranded		2x (0,5 ... 1,5 mm ²), 2x (0,75 ... 2,5 mm ²)
• finely stranded		

• with conductor end processing		2x (0.5 ... 1.5 mm ²), 2x (0.75 ... 2.5 mm ²)
Type of the connectable conductor cross-section / for AWG conductors		
• for main contacts		2x (16 ... 12), 2x (14 ... 8)
• for auxiliary contacts		2x (20 ... 16), 2x (18 ... 14)
Tightening torque / for main contacts		
• with screw-type terminals	N·m	2 ... 2.5
Design of the thread of the connection screw for main contacts		
M4	M4	
Tightening torque / for auxiliary contacts		
• with screw-type terminals	N·m	0.8 ... 1.2
Design of the thread of the connection screw of the auxiliary and control pins		
M3	M3	
Dimension de la tête de tournevis		Pozidriv 2

UL/CSA Bemessungsdaten:

yielded mechanical performance [hp] / for three-phase squirrel cage motors		
• at 220/230 V / rated value	hp	2
• at 460/480 V rated value		5
• at 575/600 V rated value		5
Full-load current (FLA) / for 3-phase motor		
• at 480 V / rated value	A	8

Approbationen/ Zertifikate:

General Product Approval	For use in hazardous locations	Declaration of Conformity	Test Certificates
 CSA	 ATEX	 EG-Konf.	Type Test Certificates/Test Report
 EAC			
 UL			

Shipping Approval



other

[Declaration of Conformity](#)

[other](#)

[Environmental Confirmations](#)

Weitere Informationen:

Information- and Downloadcenter (Kataloge, Broschüren,...)

<http://www.siemens.de/industrial-controls/catalogs>

Industry Mall (Online-Bestellsystem)

<http://www.siemens.de/industrial-controls/mall>

CAX-Online-Generator

<http://www.siemens.com/cax>

Service&Support (Handbücher, Betriebsanleitungen, Zertifikate, Kennlinien, FAQs,...)

<http://support.automation.siemens.com/WW/view/de/3RA2120-1HA24-0BB4/all>

Bilddatenbank (Produktfotos, 2D-Maßzeichnungen, 3D-Modelle, Geräteschaltpläne, ...)

http://www.automation.siemens.com/bilddb/cax_de.aspx?mlfb=3RA2120-1HA24-0BB4

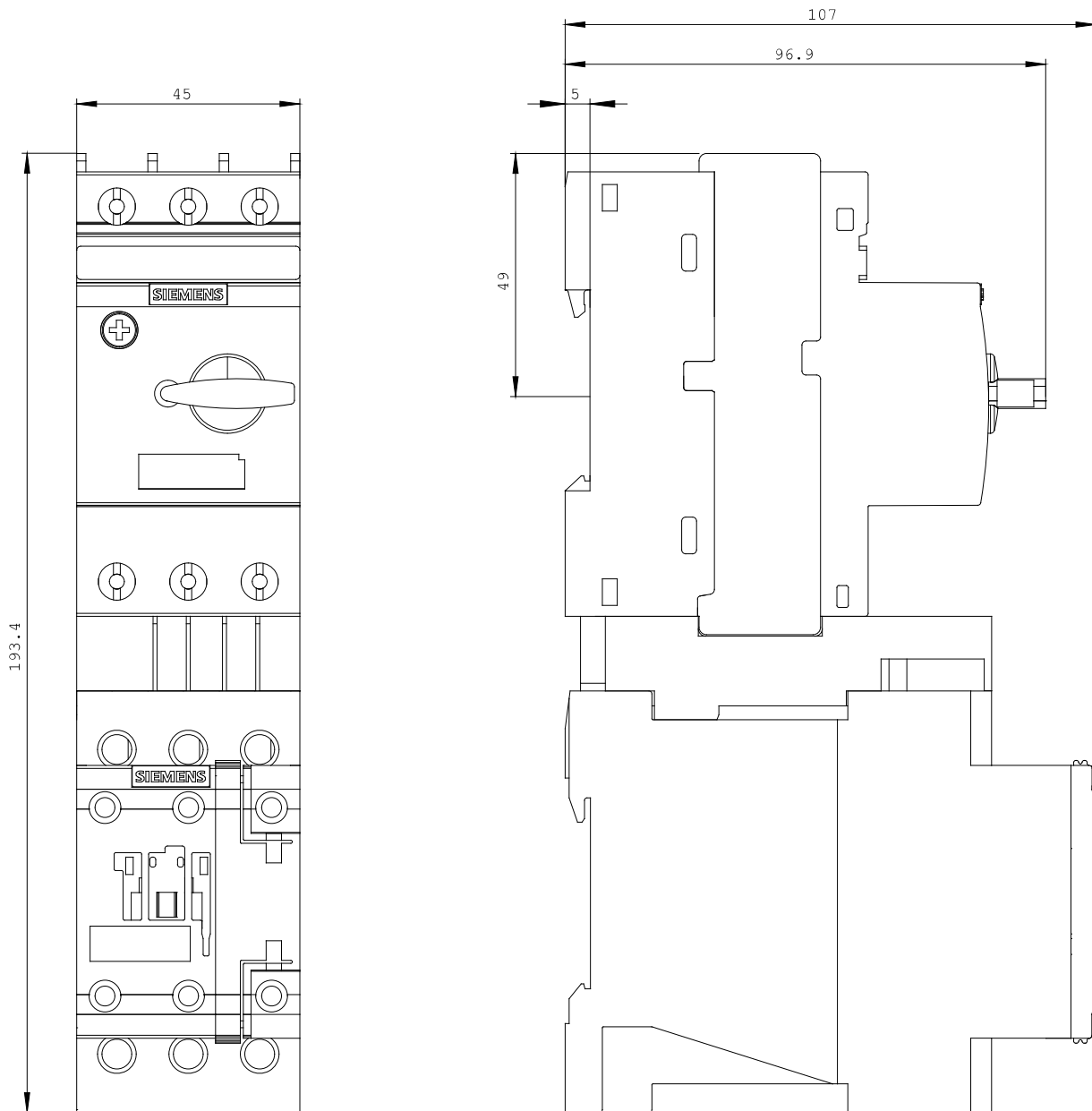

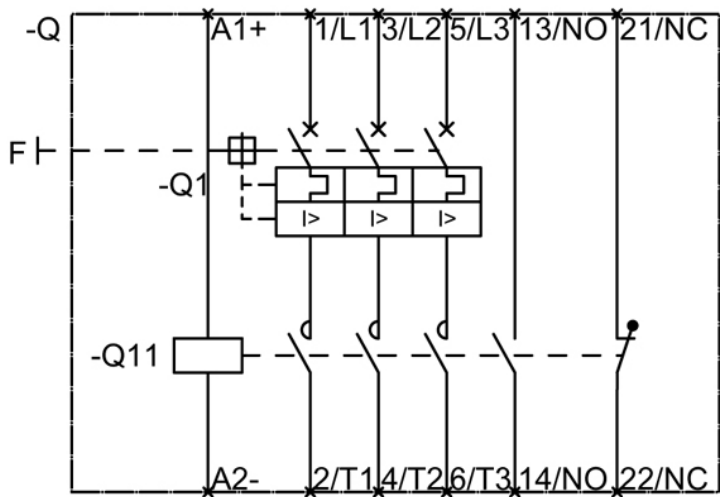

letzte Änderung:

Aug 4, 2014