



LOAD FEEDER FUSELESS DIRECT START,  
 AC 400V, SZ. S0, 9. . .12.5A,  
 AC 230V SCREW CONNECTION FOR BUSBAR SYSTEMS  
 60MM TYPE OF COORD. 2,IQ = 150KA (ALSO ACHIEVES  
 TYPE OF COORD.1) 1NO+1NC (CONTACTOR)

**Allgemeine technische Daten:**

<b>product brand name</b>		SIRIUS
<b>Product designation</b>		non-fused load feeders 3RA2
<b>Size of the load feeder</b>		S0
<b>Number of poles / for main current circuit</b>		3
<b>Installation altitude / at a height over sea level / maximum</b>	m	2,000
<b>Product function</b>		
• short circuit protection		Yes
• overload protection		Yes
• phase disturbance recognition		Yes
<b>Product component</b>		
• trip indicator		No
• auxiliary switch		No
<b>Product extension / auxiliary switch</b>		Yes
<b>Design of display / for switching status</b>		Switch setting
<b>Insulation voltage / with degree of pollution 3 / rated value</b>	V	690
<b>Impulse voltage resistance / rated value</b>	kV	6
<b>Protection class IP</b>		
• on the front		IP20
<b>Protection against electrical shock</b>		finger-safe

<b>Shock resistance / according to IEC 60068-2-27</b>		6g / 11 ms
<b>maximum permissible voltage for safe isolation in networks with non-grounded star point</b>		
<b>Ambient temperature</b>	°C	
• during transport		-50 ... +80
• during storage		-50 ... 80
• during operating		-20 ... 60
<b>Manufacturer article number</b>		
• of the circuit-breakers included in the scope of supply		<a href="#">3RV2021-1KA10</a>
• of the contactor included in the scope of supply		<a href="#">3RT2024-1AP00</a>
• of the RS applied assembly kit		
• of the link module included in the scope of supply		<a href="#">3RA2921-1AA00</a>
• of the busbar adapter included in the scope of supply		<a href="#">8US1251-5NT10</a>
• of the RH applied assembly kit		

#### Hauptstromkreis:

<b>Operating current / rated value</b>	A	32
<b>Mechanical operating cycles as operating time / of the auxiliary contacts / typical</b>		10,000,000
<b>Derating factor for rated value of the operational current</b>		
<b>Operating voltage / rated value</b>	V	690
<b>Voltage type / for main circuit</b>		AC
<b>Frequency</b>		-
<b>Service power / at AC-3</b>	W	
• at 400 V / rated value		5,500
• at 500 V rated value		5,500
• at 690 V rated value		7,500
<b>Operating current / at AC-3 / at 400 V / rated value</b>	A	11.5
<b>Type of assignment</b>		2

#### Steuerstromkreis/ Ansteuerung:

<b>Voltage type / for auxiliary and control circuit</b>		AC
<b>Apparent holding power / of the solenoid / for AC</b>	V·A	8.5

#### Hilfsstromkreis:

<b>Number of NC contacts / for auxiliary contacts</b>		1
<b>Number of NO contacts / for auxiliary contacts</b>		1
<b>Number of changeover contacts / for auxiliary contacts</b>		0

#### Schutz-/Überwachungsfunktion:

<b>Design of the overload circuit breaker</b>		thermal (bimetallic)
<b>Trip class</b>		CLASS 10

<b>Adjustable response current / of the current-dependent overload release</b>	A	9 ... 12.5
<b>Design of the short-circuit trip</b>		magnetic
<b>Conditional short-circuit current (I<sub>q</sub>)</b>		
• at 400 V / according to IEC 60947-4-1 / rated value	A	153,000
• at 500 V / according to IEC 60947-4-1 / rated value	A	42,000
• at 690 V according to IEC 60947-4-1 rated value		4,000
<b>Varification of suitability / ATEX</b>		Yes

#### Sicherheitsrelevante Kenngrößen:

<b>Proportion of dangerous failures</b>		
• with high demand rate / according to SN 31920	%	73
<b>B10 value / with high demand rate / according to SN 31920</b>		1,000,000

#### Einbau/ Befestigung/ Abmessungen:

<b>Mounting type</b>		for snapping onto 60 mm busbar systems
<b>mounting position</b>		vertical
<b>Depth</b>	mm	155
<b>Height</b>	mm	260
<b>Width</b>	mm	45
<b>Distance, to be maintained, to the ranks assembly</b>		
• upwards	mm	30
• forwards	mm	10
• sideways		0
• backwards		0
• downwards		30

#### Anschlüsse/ Klemmen:











<b>Arrangement of electrical connectors / for main current circuit</b>		from the top
<b>Design of the electrical connection</b>		
• for main current circuit		screw-type terminals
• for auxiliary and control current circuit		screw-type terminals
<b>Type of the connectable conductor cross-section for main contacts</b>		
• solid or multi-stranded		2x (1 ... 2,5 mm <sup>2</sup> ), 2x (2,5 ... 10 mm <sup>2</sup> )
• finely stranded		
• with conductor end processing		2x (1 ... 2.5 mm <sup>2</sup> ), 2x (2.5 ... 6 mm <sup>2</sup> ), 1x 10 mm <sup>2</sup>
<b>Type of the connectable conductor cross-section for auxiliary contacts</b>		
• solid or multi-stranded		2x (0,5 ... 1,5 mm <sup>2</sup> ), 2x (0,75 ... 2,5 mm <sup>2</sup> )
• finely stranded		
• with conductor end processing		2x (0.5 ... 1.5 mm <sup>2</sup> ), 2x (0.75 ... 2.5 mm <sup>2</sup> )

<b>Type of the connectable conductor cross-section / for AWG conductors</b>		
<ul style="list-style-type: none"> <li>• for main contacts</li> <li>• for auxiliary contacts</li> </ul>		2x (16 ... 12), 2x (14 ... 8) 2x (20 ... 16), 2x (18 ... 14)
<b>Tightening torque / for main contacts</b>		
<ul style="list-style-type: none"> <li>• with screw-type terminals</li> </ul>	N·m	2 ... 2.5
<b>Design of the thread of the connection screw for main contacts</b>		
M4	M4	
<b>Tightening torque / for auxiliary contacts</b>		
<ul style="list-style-type: none"> <li>• with screw-type terminals</li> </ul>	N·m	0.8 ... 1.2
<b>Design of the thread of the connection screw of the auxiliary and control pins</b>		
M3	M3	
<b>Dimension de la tête de tournevis</b>		Pozidriv 2

#### UL/CSA Bemessungsdaten:

<b>yielded mechanical performance [hp] / for three-phase squirrel cage motors</b>		
<ul style="list-style-type: none"> <li>• at 200/208 V / rated value</li> <li>• at 220/230 V / rated value</li> <li>• at 460/480 V rated value</li> <li>• at 575/600 V rated value</li> </ul>	hp	3 3 7.5 10
<b>Full-load current (FLA) / for 3-phase motor</b>		
<ul style="list-style-type: none"> <li>• at 480 V / rated value</li> </ul>	A	11

#### Approbationen/ Zertifikate:

General Product Approval	For use in hazardous locations	Declaration of Conformity	Test Certificates
 CSA	 UL	 ATEX	 EG-Konf.
			<a href="#">Type Test Certificates/Test Report</a>
Shipping Approval			
 ABS	 BUREAU VERITAS	 DNV	 GL
			 PRS
			 RINA
other			
<a href="#">Declaration of Conformity</a>	<a href="#">other</a>	<a href="#">Environmental Confirmations</a>	

#### Weitere Informationen:

**Information- and Downloadcenter (Kataloge, Broschüren,...)**  
<http://www.siemens.de/industrial-controls/catalogs>

**Industry Mall (Online-Bestellsystem)**

<http://www.siemens.de/industrial-controls/mall>

**CAX-Online-Generator**

<http://www.siemens.com/cax>

**Service&Support (Handbücher, Betriebsanleitungen, Zertifikate, Kennlinien, FAQs,...)**

<http://support.automation.siemens.com/WW/view/de/3RA2120-1KD24-0AP0/all>

**Bilddatenbank (Produktfotos, 2D-Maßzeichnungen, 3D-Modelle, Geräteschaltpläne, ...)**

[http://www.automation.siemens.com/bilddb/cax\\_de.aspx?mlfb=3RA2120-1KD24-0AP0](http://www.automation.siemens.com/bilddb/cax_de.aspx?mlfb=3RA2120-1KD24-0AP0)

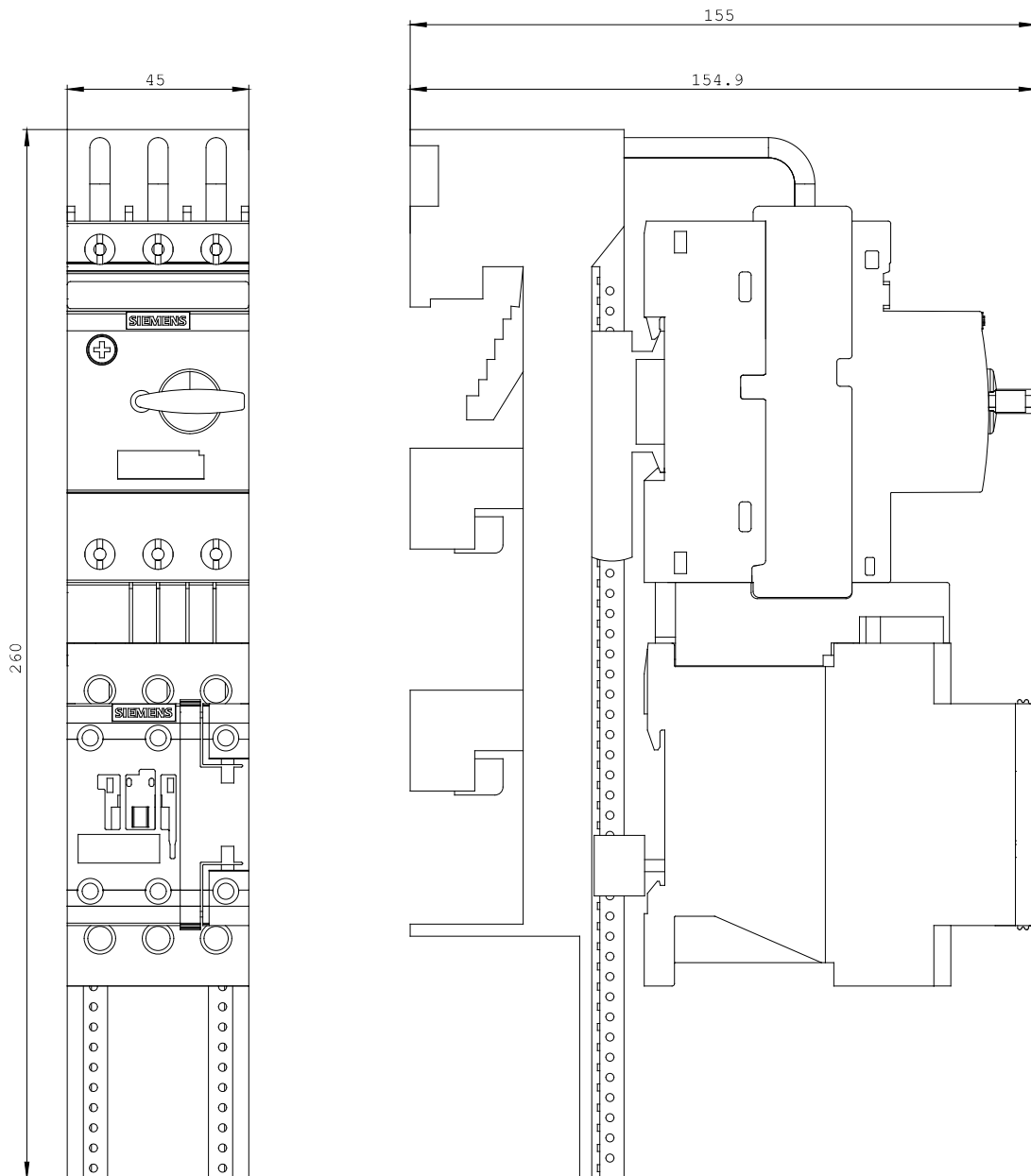

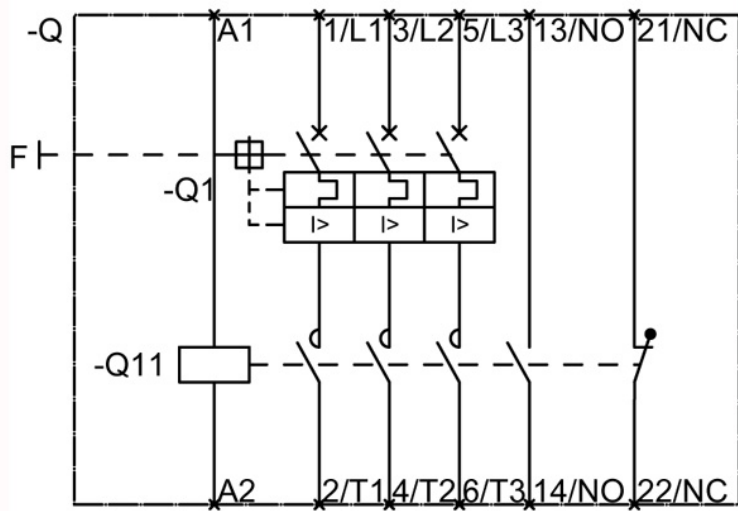

letzte Änderung:

Aug 4, 2014