



## Incremental encoders Encoder, Rotary

DGS35-1LK04096

**Model Name** > [DGS35-1LK04096](#)  
**Part No.** > [7101700](#)

---

**Product features**

Type:	Rotary
Shaft/Flange design:	Through hollow shaft
Shaft diameter:	30 mm
Remark::	P block
Interface:	5 V, TTL
Connection type:	Cable, radial, 1.5 m
Number of lines:	4,096
Number of lines/steps:	4,096

---

**Technical data**

Moment of inertia of the rotor:	490 gcm <sup>2</sup>
Measuring step:	90°/number of lines
Measuring step deviation:	45/Z °
Ambient operation temperature, min ... max:	-20 °C ... +70 °C
Max. angular acceleration:	1 x 10 <sup>5</sup> rad/s <sup>2</sup>
Operating torque:	7 Ncm
Start up torque:	9 Ncm
Resistance to shocks:	50/11 g/ms
Resistance to vibration:	5/2000 Hz @ 20 g
Supply voltage min ... max:	DC 4.75 ... 5.25 V
Permissible relative humidity:	95%
Voltage output:	DC
Working temperature range read head:	-20 °C ... +70 °C
Storage temperature range read head:	-30 °C 85 °C
Voltage area min ... max::	DC

# Maßzeichnung

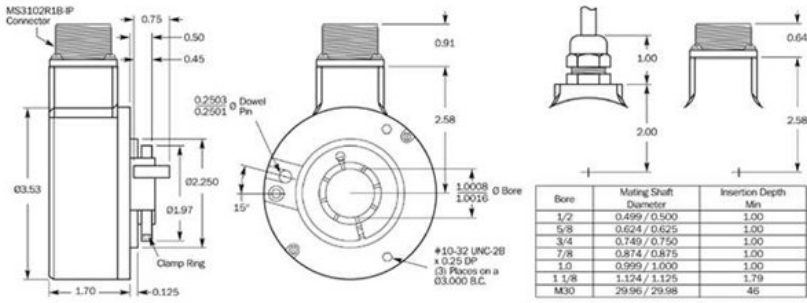

# Anschluss-Schema

Function	10 pin	Cable
A	A	White
B	B	Pink
M	C	Lilac
A not	H	Brown
B not	I	Black
M not	J	Yellow
+Vs	D	Red
Common	F	Blue
Case ground	G	N/A
Shield	N/A	N/A

**Australia**

Phone +61 3 9457 0600  
1800 334 802 – tollfree  
E-Mail sales@sick.com.au

**Belgium/Luxembourg**

Phone +32 (0)2 466 55 66  
E-Mail info@sick.be

**Brasil**

Phone +55 11 3215-4900  
E-Mail sac@sick.com.br

**Canada**

Phone +1 905 771 14 44  
E-Mail information@sick.com

**Ceská Republika**

Phone +420 2 57 91 18 50  
E-Mail sick@sick.cz

**China**

Phone +86 4000 121 000  
E-Mail info.china@sick.net.cn  
Phone +852-2153 6300  
E-Mail ghk@sick.com.hk

**Danmark**

Phone +45 45 82 64 00  
E-Mail sick@sick.dk

**Deutschland**

Phone +49 211 5301-301  
E-Mail kundenservice@sick.de

**España**

Phone +34 93 480 31 00  
E-Mail info@sick.es

**France**

Phone +33 1 64 62 35 00  
E-Mail info@sick.fr

**Great Britain**

Phone +44 (0)1727 831121  
E-Mail info@sick.co.uk

**India**

Phone +91-22-4033 8333  
E-Mail info@sick-india.com

**Israel**

Phone +972-4-6801000  
E-Mail info@sick-sensors.com

**Italia**

Phone +39 02 27 43 41  
E-Mail info@sick.it

**Japan**

Phone +81 (0)3 3358 1341  
E-Mail support@sick.jp

**Magyarország**

Phone +36 1 371 2680  
E-Mail office@sick.hu

**Nederlands**

Phone +31 (0)30 229 25 44  
E-Mail info@sick.nl

**Norge**

Phone +47 67 81 50 00  
E-Mail austefjord@sick.no

**Österreich**

Phone +43 (0)22 36 62 28 8-0  
E-Mail office@sick.at

**Polska**

Phone +48 22 837 40 50  
E-Mail info@sick.pl

**România**

Phone +40 356 171 120  
E-Mail office@sick.ro

**Russia**

Phone +7-495-775-05-30  
E-Mail info@sick.ru

**Schweiz**

Phone +41 41 619 29 39  
E-Mail contact@sick.ch

**Singapore**

Phone +65 6744 3732  
E-Mail admin@sicksgp.com.sg

**Slovenija**

Phone +386 (0)1-47 69 990  
E-Mail office@sick.si

**South Africa**

Phone +27 11 472 3733  
E-Mail info@sickautomation.co.za

**South Korea**

Phone +82 2 786 6321/4  
E-Mail info@sickkorea.net

**Suomi**

Phone +358-9-25 15 800  
E-Mail sick@sick.fi

**Sverige**

Phone +46 10 110 10 00  
E-Mail info@sick.se

**Taiwan**

Phone +886-2-2375-6288  
E-Mail sales@sick.com.tw

**Türkiye**

Phone +90 (216) 528 50 00  
E-Mail info@sick.com.tr

**United Arab Emirates**

Phone +971 (0) 4 8865 878  
E-Mail info@sick.ae

**USA/México**

Phone +1(952) 941-6780  
1 800-325-7425 – tollfree  
E-Mail info@sickusa.com

More representatives and agencies  
at [www.sick.com](http://www.sick.com)