



Motor feedback systems rotary incremental with commutation CKS36

CKS36-AFB40010



Model Name > [CKS36-AFB40010](#)
Part No. > [1036732](#)



Illustration may differ

At a glance

- Output driver for incremental and commutation signals as per EIA 422
- Resolution of up to 2,048 lines per revolution
- Commutation signals up to 32 pole pairs
- Individual programming of the line count, pole pair number and zero pulse width
- High resistance to shock and vibration
- System compensates for eccentricity errors due to holistic scanning
- Allows for high angular speeds

Your benefits

- The CKS36's small dimensions allows manufacturers to considerably reduce the size of their motors
- Programmable version for a reduced product variety
- High level of compatibility thanks to standard interface

Performance

Number of the absolute ascertainable revolutions:	1 (Singleturn)
Number of lines per revolution:	1,024
Measuring step:	90 ° /number of lines
Commutation signals:	10 pole pairs (according to EIA 422)
Zero pulse width:	90 °
Reference signal, number:	1
Reference signal, position:	90 ° or 180 ° configurable, electronically, gated with A and B
Error limits:	± 0.09 °
Measuring step deviation:	± 0.035 °
Operating speed:	12,000 /min, working speed up to which the output signals are correct

Mechanical data

Shaft version:	Tapered shaft
Flange type/stator coupling:	Spring mounting plate
Dimensions:	See dimensional drawing
Mass:	0.065 kg
Moment of inertia of the rotor:	4.5 gcm ²
Maximum operating speed:	120,000 /min ¹⁾
Maximum angular acceleration:	500,000 rad/s ²
Operating torque:	0.2 Ncm
Start up torque:	0.3 Ncm
Permissible shaft movement, radial, static:	± 0.1 mm
Permissible shaft movement, radial, dynamic:	± 0.05 mm

Permissible shaft movement, axial, static:	± 0.2 mm
Permissible shaft movement, axial, dynamic:	± 0.1 mm
Life of ball bearings:	3.6 x 10 ⁹ revolutions
Connection type:	Connector, 14-pin, axial

¹⁾ Self warming of 1.1 K per 1000 revolutions/min when applying note working temperature range

Electrical data

Electrical interface:	TTL/RS422
Operating voltage range/supply Voltage:	4.5 V DC ... 5.5 V DC
Maximum output frequency:	400 kHz
Operating power consumption (no load):	< 60 mA ¹⁾

¹⁾ Without load

Ambient data

Working temperature range:	-20 °C ... 110 °C
Storage temperature range:	-40 °C ... 125 °C, without package
Relative humidity/Condensation:	90 %, Condensation not permitted
Resistance to shocks:	100 g, 6 ms (according to EN 60068-2-27)
Resistance to vibration:	50 g, 10 Hz ... 2,000 Hz (according to EN 60068-2-6)
EMC:	(according to EN 61000-6-2 and EN 61000-6-3) ¹⁾
Enclosure rating:	IP 50 (according to IEC 60529), with mating connector inserted and closed cover

¹⁾ The EMC according to the standards quoted is achieved when the motor feedback system is mounted in an electrically conductive housing, which is connected to the central earthing point of the motor controller via a cable screen. This is also where the GND (0 V) connection of the power supply voltage is linked to earth. Users must perform their own tests when other screen designs are used.

Dimensional drawing

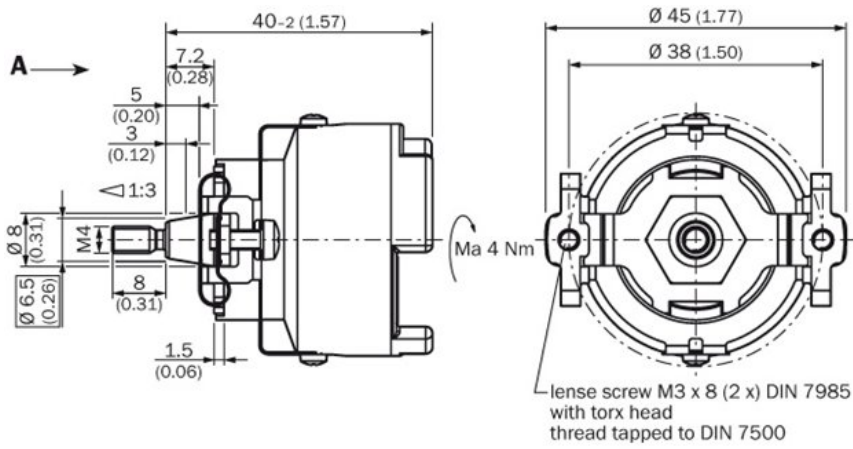

All dimensions in mm (inch)

Proposed fitting

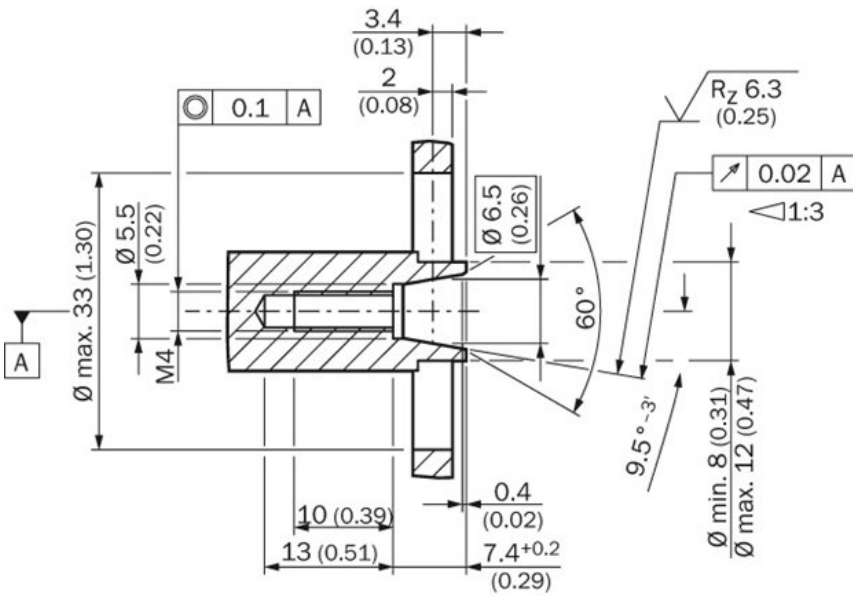

All dimensions in mm (inch)

Australia

Phone +61 3 9457 0600
1800 334 802 – tollfree
E-Mail sales@sick.com.au

Belgium/Luxembourg

Phone +32 (0)2 466 55 66
E-Mail info@sick.be

Brasil

Phone +55 11 3215-4900
E-Mail sac@sick.com.br

Canada

Phone +1 905 771 14 44
E-Mail information@sick.com

Ceská Republika

Phone +420 2 57 91 18 50
E-Mail sick@sick.cz

China

Phone +86 4000 121 000
E-Mail info.china@sick.net.cn
Phone +852-2153 6300
E-Mail ghk@sick.com.hk

Danmark

Phone +45 45 82 64 00
E-Mail sick@sick.dk

Deutschland

Phone +49 211 5301-301
E-Mail kundenservice@sick.de

España

Phone +34 93 480 31 00
E-Mail info@sick.es

France

Phone +33 1 64 62 35 00
E-Mail info@sick.fr

Great Britain

Phone +44 (0)1727 831121
E-Mail info@sick.co.uk

India

Phone +91-22-4033 8333
E-Mail info@sick-india.com

Israel

Phone +972-4-6801000
E-Mail info@sick-sensors.com

Italia

Phone +39 02 27 43 41
E-Mail info@sick.it

Japan

Phone +81 (0)3 3358 1341
E-Mail support@sick.jp

Magyarország

Phone +36 1 371 2680
E-Mail office@sick.hu

Nederlands

Phone +31 (0)30 229 25 44
E-Mail info@sick.nl

Norge

Phone +47 67 81 50 00
E-Mail austefjord@sick.no

Österreich

Phone +43 (0)22 36 62 28 8-0
E-Mail office@sick.at

Polska

Phone +48 22 837 40 50
E-Mail info@sick.pl

România

Phone +40 356 171 120
E-Mail office@sick.ro

Russia

Phone +7-495-775-05-30
E-Mail info@sick.ru

Schweiz

Phone +41 41 619 29 39
E-Mail contact@sick.ch

Singapore

Phone +65 6744 3732
E-Mail admin@sicksgp.com.sg

Slovenija

Phone +386 (0)1-47 69 990
E-Mail office@sick.si

South Africa

Phone +27 11 472 3733
E-Mail info@sickautomation.co.za

South Korea

Phone +82 2 786 6321/4
E-Mail info@sickkorea.net

Suomi

Phone +358-9-25 15 800
E-Mail sick@sick.fi

Sverige

Phone +46 10 110 10 00
E-Mail info@sick.se

Taiwan

Phone +886-2-2375-6288
E-Mail sales@sick.com.tw

Türkiye

Phone +90 (216) 528 50 00
E-Mail info@sick.com.tr

United Arab Emirates

Phone +971 (0) 4 8865 878
E-Mail info@sick.ae

USA/México

Phone +1(952) 941-6780
1 800-325-7425 – tollfree
E-Mail info@sickusa.com

More representatives and agencies
at www.sick.com