



Safety light curtains miniTwin4

C4MT-01824ABB03BB0



Model Name > C4MT-01824ABB03BB0
Part No. > 1207177



At a glance

- Type 4 (IEC 61496), PL e (EN ISO 13849)
- Compact cross section (15 x 32 mm) with no dead zones
- Cascadable twin stick design - sender and receiver in a single housing
- Customized protective field heights in 60-mm increments from 120 to 1200 mm
- Typical scanning ranges 0 ... 5 m
- Intelligent, software-free configuration of external device monitoring (EDM) and reset function (RES)
- M12, 5-pin device connection

Your benefits

- Cost-effective machine integration: its small design, cascadable features and incremental protective field heights enable a flexible adjustment to the machine design
- Standardization saves time and resources because of more straightforward logistics, order entry and service
- Simplified handling and setup: Software-free, almost fully automatic commissioning and intuitive operation with sustainable optics
- Bright LED display provides fast alignment, easy start up and clear protective field visualization ensure quick diagnostics
- End-to-end coverage in cascadable applications eliminates dead zones and shortens the safety distance, increasing productivity
- Application-specific brackets provide increased flexibility and reduce installation time



Functions

Restart interlock:	✓
Restart interlock (delivery status):	Deactivated
External device monitoring (EDM):	✓
External device monitoring (delivery status):	Deactivated
Beam coding:	✓
Bypass (with UE402):	-
Operating mode switching (with UE402):	-
Type of blanking:	No
Reduced resolution:	-
SDL interface:	-
Muting with:	Flexi Classic, Flexi Soft

Configuration method:	Hard wired
Extension connection:	-
PSDI mode with:	Flexi Soft
Safe device communication via EFI/SDL:	-

Technical data

Scanning range from ... to:	0 m ... 4 m
Scanning range typ.:	0 m ... 5 m
Housing length:	180 mm
Weight:	75 g
Ambient operating temperature from ... to:	-20 °C ... 55 °C
Vibration resistance (checked to):	5 g (IEC 60068-2-6)
Oscillation frequency from ... to:	10 Hz ... 55 Hz
Response time:	13 ms ¹⁾
Supply voltage typical, from, to:	24 V DC, 19.2 V DC, 28.8 V DC
Maximum switching current:	300 mA
Wave length:	850 nm
Maximum connection cable cross-section:	0.34 mm ²
Mounting system type:	O-fix bracket
Extension connection usage:	Stand alone
Resolution:	24 mm
Protective field height:	180 mm
Type:	Type 4 (IEC 61496)
Safety integrity level:	SIL3 (IEC 61508), SILCL3 (IEC 62061)
Category:	Category 4 (EN ISO 13849)
Performance level:	PL e EN ISO 13849
PFHd:	Standalone system: 4.3 * 1E-09 (EN ISO 13849)
TM (mission time):	20 a
Protection class:	III (EN 61140)
Cable length:	160 mm
Enclosure rating:	IP 65 (EN 60529)
Shock resistance:	10 g, 16 ms (IEC 60068-2-29)
Housing cross-section:	15 mm x 32 mm

¹⁾ Standalone devices, no cascaded systems. Other response times see operating instructions.

Dimensional drawing

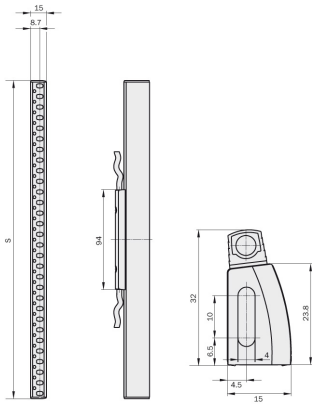

Australia

Phone +61 3 9457 0600
1800 334 802 – tollfree
E-Mail sales@sick.com.au

Belgium/Luxembourg

Phone +32 (0)2 466 55 66
E-Mail info@sick.be

Brasil

Phone +55 11 3215-4900
E-Mail sac@sick.com.br

Canada

Phone +1 905 771 14 44
E-Mail information@sick.com

Ceská Republika

Phone +420 2 57 91 18 50
E-Mail sick@sick.cz

China

Phone +86 4000 121 000
E-Mail info.china@sick.net.cn
Phone +852-2153 6300
E-Mail ghk@sick.com.hk

Danmark

Phone +45 45 82 64 00
E-Mail sick@sick.dk

Deutschland

Phone +49 211 5301-301
E-Mail kundenservice@sick.de

España

Phone +34 93 480 31 00
E-Mail info@sick.es

France

Phone +33 1 64 62 35 00
E-Mail info@sick.fr

Great Britain

Phone +44 (0)1727 831121
E-Mail info@sick.co.uk

India

Phone +91-22-4033 8333
E-Mail info@sick-india.com

Israel

Phone +972-4-6801000
E-Mail info@sick-sensors.com

Italia

Phone +39 02 27 43 41
E-Mail info@sick.it

Japan

Phone +81 (0)3 3358 1341
E-Mail support@sick.jp

Magyarország

Phone +36 1 371 2680
E-Mail office@sick.hu

Nederlands

Phone +31 (0)30 229 25 44
E-Mail info@sick.nl

Norge

Phone +47 67 81 50 00
E-Mail austefjord@sick.no

Österreich

Phone +43 (0)22 36 62 28 8-0
E-Mail office@sick.at

Polska

Phone +48 22 837 40 50
E-Mail info@sick.pl

România

Phone +40 356 171 120
E-Mail office@sick.ro

Russia

Phone +7-495-775-05-30
E-Mail info@sick.ru

Schweiz

Phone +41 41 619 29 39
E-Mail contact@sick.ch

Singapore

Phone +65 6744 3732
E-Mail admin@sicksgp.com.sg

Slovenija

Phone +386 (0)1-47 69 990
E-Mail office@sick.si

South Africa

Phone +27 11 472 3733
E-Mail info@sickautomation.co.za

South Korea

Phone +82 2 786 6321/4
E-Mail info@sickkorea.net

Suomi

Phone +358-9-25 15 800
E-Mail sick@sick.fi

Sverige

Phone +46 10 110 10 00
E-Mail info@sick.se

Taiwan

Phone +886-2-2375-6288
E-Mail sales@sick.com.tw

Türkiye

Phone +90 (216) 528 50 00
E-Mail info@sick.com.tr

United Arab Emirates

Phone +971 (0) 4 8865 878
E-Mail info@sick.ae

USA/México

Phone +1(952) 941-6780
1 800-325-7425 – tollfree
E-Mail info@sickusa.com

More representatives and agencies
at www.sick.com