



Network solutions Flexi Classic Gateways

UE410-EN4



Model Name > [UE410-EN4](#)
Part No. > [1044078](#)



At a glance

- Gateway collects all information of the system
- The supervisor PLC can read out of the gateway and/or the gateway can write into a PLC by itself
- Addition of 1 gateway to the Flexi Classic system
- Small width of 22.5 mm

Your benefits

- Reduced downtime due to quick and easy diagnostics
- Support for all major fieldbus protocols
- All information at a glance



Functions

Safe device communication via EFI/SDL: -

Electrical data

Supply voltage: 24 V DC (19.2 V DC ... 30 V DC)
Power consumption: 2.4 W

Ambient data

Weight: 160 g
Connection type: Cable gland
Connection type: Screw-terminal connector
Dimensions (W x H x D): 22.5 mm x 96.5 mm x 120.8 mm
Protection class standard: EN/IEC 60529
Enclosure rating terminals: IP 20
Vibration resistance: 5 g, 5 Hz ... 500 Hz (EN 60068-2-6)
Ambient operating temperature: -25 °C ... 55 °C
Storage temperature: -25 °C ... 70 °C
Air humidity: 15 % ... 95 %, non-condensing
Climate conditions according to: EN 61131-2
Electromagnetic compatibility (EMC): EN 61000
EN 55011
Protection class according to IEC 60529: IP 40

Connection diagram

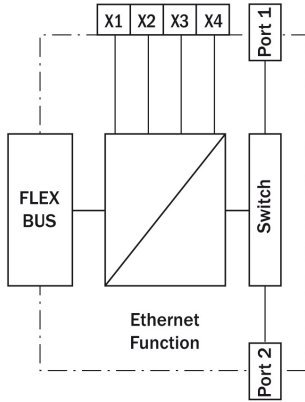

Australia

Phone +61 3 9457 0600
1800 334 802 – tollfree
E-Mail sales@sick.com.au

Belgium/Luxembourg

Phone +32 (0)2 466 55 66
E-Mail info@sick.be

Brasil

Phone +55 11 3215-4900
E-Mail sac@sick.com.br

Canada

Phone +1 905 771 14 44
E-Mail information@sick.com

Ceská Republika

Phone +420 2 57 91 18 50
E-Mail sick@sick.cz

China

Phone +86 4000 121 000
E-Mail info.china@sick.net.cn
Phone +852-2153 6300
E-Mail ghk@sick.com.hk

Danmark

Phone +45 45 82 64 00
E-Mail sick@sick.dk

Deutschland

Phone +49 211 5301-301
E-Mail kundenservice@sick.de

España

Phone +34 93 480 31 00
E-Mail info@sick.es

France

Phone +33 1 64 62 35 00
E-Mail info@sick.fr

Great Britain

Phone +44 (0)1727 831121
E-Mail info@sick.co.uk

India

Phone +91-22-4033 8333
E-Mail info@sick-india.com

Israel

Phone +972-4-6801000
E-Mail info@sick-sensors.com

Italia

Phone +39 02 27 43 41
E-Mail info@sick.it

Japan

Phone +81 (0)3 3358 1341
E-Mail support@sick.jp

Magyarország

Phone +36 1 371 2680
E-Mail office@sick.hu

Nederlands

Phone +31 (0)30 229 25 44
E-Mail info@sick.nl

Norge

Phone +47 67 81 50 00
E-Mail austefjord@sick.no

Österreich

Phone +43 (0)22 36 62 28 8-0
E-Mail office@sick.at

Polska

Phone +48 22 837 40 50
E-Mail info@sick.pl

România

Phone +40 356 171 120
E-Mail office@sick.ro

Russia

Phone +7-495-775-05-30
E-Mail info@sick.ru

Schweiz

Phone +41 41 619 29 39
E-Mail contact@sick.ch

Singapore

Phone +65 6744 3732
E-Mail admin@sicksgp.com.sg

Slovenija

Phone +386 (0)1-47 69 990
E-Mail office@sick.si

South Africa

Phone +27 11 472 3733
E-Mail info@sickautomation.co.za

South Korea

Phone +82 2 786 6321/4
E-Mail info@sickkorea.net

Suomi

Phone +358-9-25 15 800
E-Mail sick@sick.fi

Sverige

Phone +46 10 110 10 00
E-Mail info@sick.se

Taiwan

Phone +886-2-2375-6288
E-Mail sales@sick.com.tw

Türkiye

Phone +90 (216) 528 50 00
E-Mail info@sick.com.tr

United Arab Emirates

Phone +971 (0) 4 8865 878
E-Mail info@sick.ae

USA/México

Phone +1(952) 941-6780
1 800-325-7425 – tollfree
E-Mail info@sickusa.com

More representatives and agencies
at www.sick.com