

**Inductive sensor  
ring sensor  
BI6R-Q14-AN6X2-H1141**

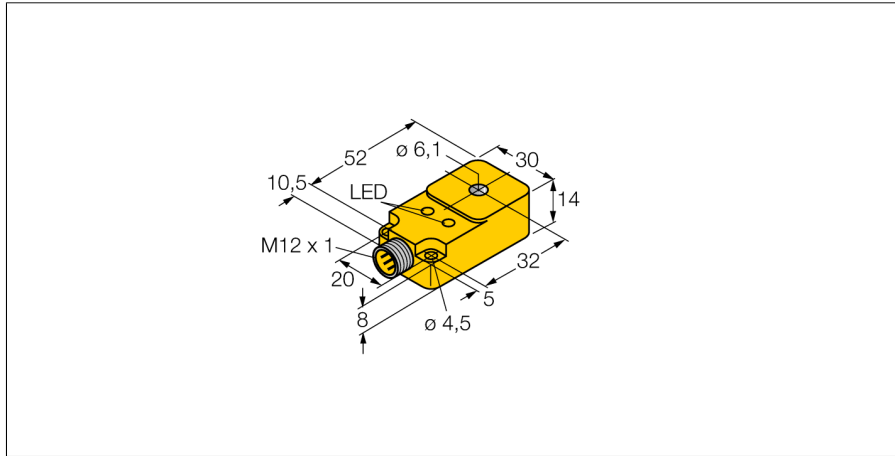

- Rectangular, height 14 mm
- Plastic, PBT-GF30-V0
- Static output performance
- Output pulse length min. 100 ms
- 3-wire DC, 10...30 VDC
- NO contact, NPN output
- Male M12 x 1

**Wiring diagram**

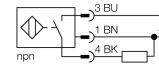

<b>Type code</b>	BI6R-Q14-AN6X2-H1141
Ident no.	1407020
<b>Inside ring diameter D</b>	6.1 mm
Steel ball diameter (DIN 5401)	≥ 2 mm
Fly-by speed	1...28 m/s
pulse stop	≥ 5 ms
Pulse duration at the output	100 ms ± 20 %
Ambient temperature	-25...+70 °C
<b>Operating voltage</b>	10...30VDC
Residual ripple	≤ 10 % U <sub>in</sub>
DC rated operational current	≤ 200 mA
No-load current I <sub>0</sub>	≤ 15 mA
Residual current	≤ 0.1 mA
Rated insulation voltage	≤ 0.5 kV
Short-circuit protection	yes/ cyclic
Voltage drop at I <sub>0</sub>	≤ 1.8 V
Wire breakage / Reverse polarity protection	yes/ complete
Output function	3-wire, NO contact, NPN
Switching frequency	0.008 kHz
<b>Design</b>	ring sensor, Q14
Dimensions	62.5 x 30 x 14 mm
Housing material	plastic, PBT
Connection	male, M12 x 1
Coil body	plastic, POM
Vibration resistance	55 Hz (1 mm)
Shock resistance	30 g (11 ms)
Protection class	IP67
MTTF	2283 years acc. to SN 29500 (Ed. 99) 40 °C
<b>Power-on indication</b>	LED green
Switching state	LED yellow

**Functional principle**

Inductive sensors detect metal objects contactless and wear-free. For this purpose they use a high-frequency electromagnetic AC field that interacts with the target. Inductive ring sensors generate this field through an LC resonant circuit. The target acts as the coil core.

**Inductive sensor  
ring sensor  
BI6R-Q14-AN6X2-H1141**

---

Distance D	45 mm
Distance W	45 mm
Distance S	14 mm
Distance G	30 mm



**Inductive sensor  
ring sensor  
BI6R-Q14-AN6X2-H1141**

**Wiring accessories**

Type code	Ident no.	Description	Dimension drawing
RKC4T-2/TEL	6625010	Connection cable, female M12, straight, 3-pin, cable length: 2 m, sheath material: PVC, black; cULus approval; other cable lengths and qualities available, see <a href="http://www.turck.com">www.turck.com</a>	