

**Inductive sensor**  
**BI1,5-EG08-AP6X-V1131**

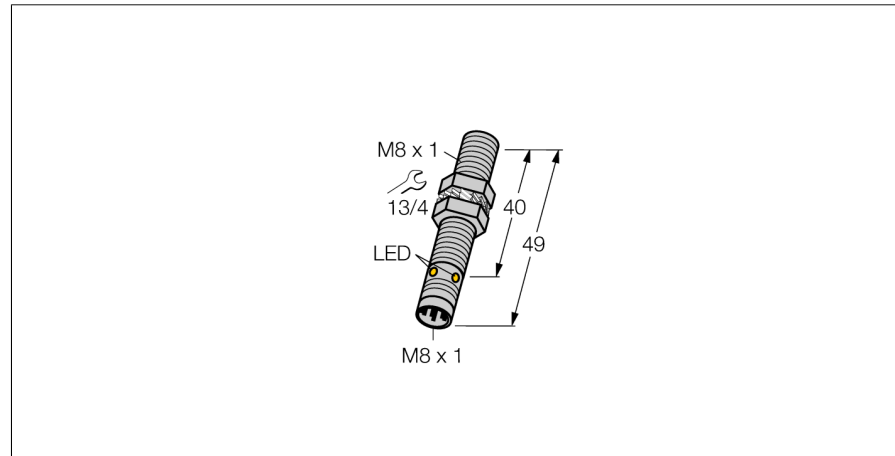

- Threaded barrel, M8 x 1
- Stainless steel, 1.4427 SO
- 3-wire DC, 10...30 VDC
- NO contact, PNP output
- Male M8 x 1

**Wiring diagram**

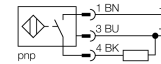

|   |   |
|---|---|
| <b>Type code</b>                            | BI1,5-EG08-AP6X-V1131                               |
| Ident no.                                   | 4602220   |
| <b>Rated operating distance Sn</b>          | 1.5 mm  |
| Mounting condition                          | flush   |
| Assured sensing range                       | ≤ (0,81 x Sn) mm                                    |
| Correction factors                          | St37 = 1; Al = 0.3; stainless steel = 0.7; Ms = 0.4 |
| Repeatability                               | ≤ 2 % of full scale                                 |
| Temperature drift                           | 10 %  |
| Hysteresis                                  | 3...15 %  |
| Ambient temperature                         | -25...+70 °C  |
| <b>Operating voltage</b>                    | 10...30VDC  |
| Residual ripple                             | ≤ 10 % U <sub>ss</sub>                              |
| DC rated operational current                | ≤ 150 mA  |
| No-load current I <sub>0</sub>              | ≤ 15 mA   |
| Residual current                            | ≤ 0.1 mA  |
| Rated insulation voltage                    | ≤ 0.5 kV  |
| Short-circuit protection                    | yes/ cyclic   |
| Voltage drop at I <sub>0</sub>              | ≤ 1.8 V   |
| Wire breakage / Reverse polarity protection | yes/ complete                                       |
| Output function                             | 3-wire, NO contact, PNP                             |
| Switching frequency                         | 3 kHz   |
| <b>Design</b>                               | threaded barrel, M8 x 1                             |
| Dimensions                                  | 49 mm   |
| Housing material                            | stainless steel, 1.4427 SO                          |
| Material active area                        | Plastic, PA   |
| Max. tightening torque housing nut          | 10 Nm   |
| Connection                                  | male, M8 x 1  |
| Vibration resistance                        | 55 Hz (1 mm)  |
| Shock resistance                            | 30 g (11 ms)  |
| Protection class                            | IP67  |
| MTTF  | 2283 years acc. to SN 29500 (Ed. 99) 40 °C          |
| <b>Switching state</b>                      | LED yellow  |

**Functional principle**

Inductive sensors detect metal objects contactless and wear-free. For this, they use a high-frequency electromagnetic AC field that interacts with the target. Inductive sensors generate this field via an RLC circuit with a ferrite coil.

We offer special versions for temperatures of -60 °C up to +250 °C.

**Inductive sensor**  
**BI1,5-EG08-AP6X-V1131**

|                               |         |
|-------------------------------|---------|
| Distance D                    | 2 x B   |
| Distance W                    | 3 x Sn  |
| Distance T                    | 3 x B   |
| Distance S                    | 1.5 x B |
| Distance G                    | 6 x Sn  |
| <hr/>                         |         |
| Diameter of the active area B | Ø 8 mm  |



**Inductive sensor**  
**BI1,5-EG08-AP6X-V1131**

**TURCK**

Industrial  
Automation

**Accessories**

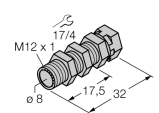
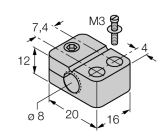
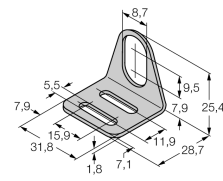
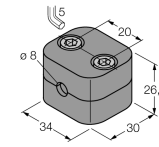
| Type code | Ident no. | Description  | Dimension drawing   |
|-----------|-----------|--|---|
| QM-08     | 6945100   | Quick-mount bracket with dead-stop, chrome-plated brass, male thread M12 x 1. Note: The switching distance of proximity switches may be reduced through the use of quick-mount brackets. |    |
| BST-08B   | 6947210   | Fixing clamp for threaded barrel devices, with dead-stop; material: PA6  |    |
| MW-08     | 6945008   | Mounting bracket for threaded barrel devices; material: Stainless steel A2 1.4301 (AISI 304)   |  |
| BSS-08    | 6901322   | Mounting bracket for smooth and threaded barrel devices; material: Polypropylene   |  |

**Wiring accessories**

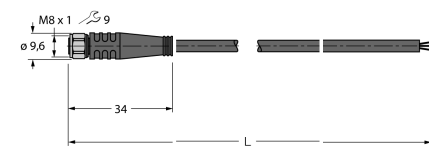
| Type code   | Ident no. | Description   | Dimension drawing   |
|-------------|-----------|---|---|
| PKG3M-2/TEL | 6625385   | Connection cable, female M8, straight, 3-pin, stainless steel coupling nut, cable length: 2 m, sheath material: PVC, black; cULus approval; other cable lengths and qualities available, see <a href="http://www.turck.com">www.turck.com</a> |  |