

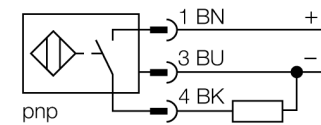

- Threaded barrel, M12 x 1
- Plastic, PBT-GF30-V0
- Factor 1 for all metals
- Protection class IP68
- Resistant to magnetic fields
- Extended temperature range
- High switching frequency
- 3-wire DC, 10...30 VDC
- NO contact, PNP output
- Male M12 x 1

Wiring diagram



Functional principle

Inductive sensors detect metal objects contactless and wear-free. Due to the patented multicoil system, uprox®+ sensors have distinct advantages over conventional sensors. They detect all metals at the same large switching distance and are resistant to magnetic fields.

Type code	BI3U-S12-AP6X-H1141
Ident no.	1634600
Rated operating distance Sn	3 mm
Mounting condition	flush
Assured sensing range	≤ (0,81 x Sn) mm
Repeatability	≤ 2 % of full scale
Temperature drift	10 %
	≤ ± 15 %, ≤ -25 °C v ≥ +70 °C
Hysteresis	3...15 %
Ambient temperature	-30...+85 °C
Operating voltage	10...30VDC
Residual ripple	≤ 10 % U _{ss}
DC rated operational current	≤ 200 mA
No-load current I ₀	≤ 15 mA
Residual current	≤ 0.1 mA
Rated insulation voltage	≤ 0.5 kV
Short-circuit protection	yes/ cyclic
Voltage drop at I _e	≤ 1.8 V
Wire breakage / Reverse polarity protection	yes/ complete
Output function	3-wire, NO contact, PNP
Protection class	☐
Switching frequency	3 kHz
Design	threaded barrel, M12 x 1
Dimensions	52 mm
Housing material	plastic, PBT
Material active area	Plastic, PBT
Max. tightening torque housing nut	1 Nm
Connection	male, M12 x 1
Vibration resistance	55 Hz (1 mm)
Shock resistance	30 g (11 ms)
Protection class	IP68
MTTF	874 years acc. to SN 29500 (Ed. 99) 40 °C
Switching state	LED yellow

Distance D	2 x B
Distance W	3 x Sn
Distance T	3 x B
Distance S	1.5 x B
Distance G	6 x Sn

Diameter of the active area B	Ø 12 mm
-------------------------------	---------

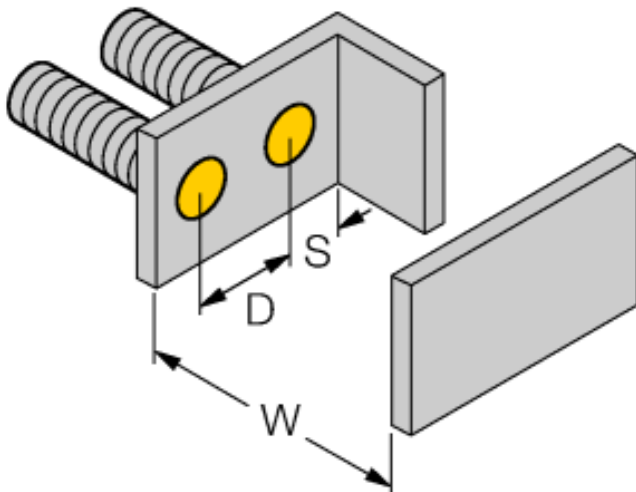
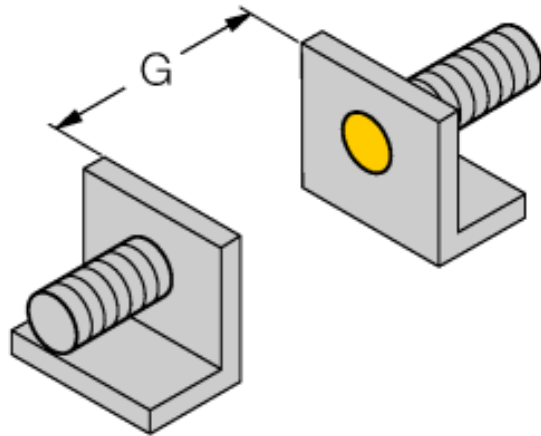

Accessories

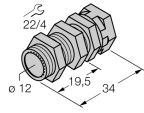
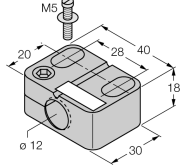
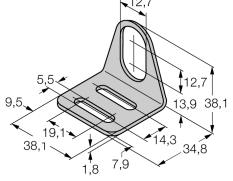
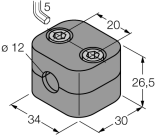
Type code	Ident no.	Description	Dimension drawing
QM-12	6945101	Quick-mount bracket with dead-stop; material: Chrome-plated brass Male thread M16 x 1. Note: The switching distance of proximity switches can be reduced by the use of quick-mount brackets.	
BST-12B	6947212	Fixing clamp for threaded barrel devices, with dead-stop; material: PA6	
MW-12	6945003	Mounting bracket for threaded barrel devices; material: Stainless steel A2 1.4301 (AISI 304)	
BSS-12	6901321	Mounting bracket for smooth and threaded barrel devices; material: Polypropylene	

Wiring accessories

Type code	Ident no.	Description	Dimension drawing
RKC4T-2/TEL	6625010	Connection cable, female M12, straight, 3-pin, cable length: 2 m, sheath material: PVC, black; cULus approval; other cable lengths and qualities available, see www.turck.com	