

**Inductive sensor
with analog output
BI15-M30-LI-EXI**

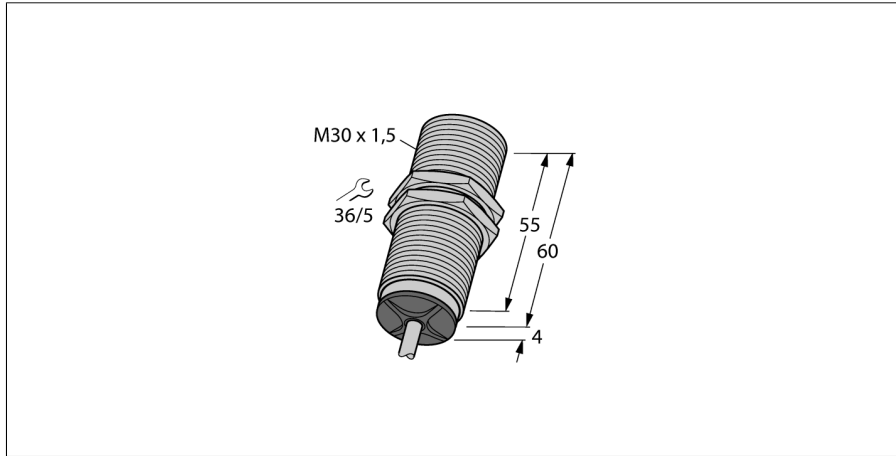

- ATEX category II 1 G, Ex-zone 0
- ATEX category II 2 D, Ex-zone 21
- Threaded barrel, M30 x 1.5
- Chrome-plated brass
- 2-wire, 14...30 VDC
- Analog output
- 4...20 mA
- Cable connection

Wiring diagram

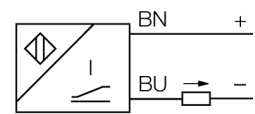

Functional principle

Inductive TURCK sensors with analog output accomplish simple control tasks. They provide a current, voltage or frequency signal proportional to the target's distance. The output signal is linear to the distance of the target over the entire sensing range.

Measuring range

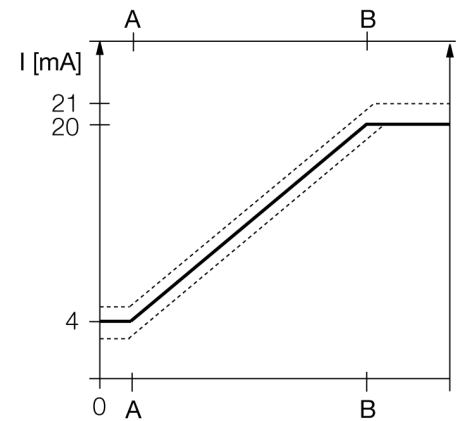

Type code	BI15-M30-LI-EXI
Ident no.	1535554
Measuring range [A...B]	2...10mm
Mounting condition	flush
Correction factors	St37 = 1; Al = 0.3; stainless steel = 0.7; Ms = 0.4
Repeatability	≤ 1 % of measuring range A - B
	≤ 0.5 %, after warm-up 0.5 h
Linearity deviation	≤ 5 %
Temperature drift	≤ ± 0.06 % / K
Ambient temperature	-25...+70 °C
	in the explosion hazardous area see instruction leaflet
Operating voltage	14...30VDC
	at the electrical connection of the sensor
Residual ripple	≤ 10 % U _s
Rated insulation voltage	≤ 0.5 kV
Short-circuit protection	yes
Wire breakage / Reverse polarity protection	yes/ complete
Output function	2-wire, analog output
Current output	4...20mA
Load resistance current output	≤ [(U _s - 14 V) / 20 mA] kΩ
Measuring sequence frequency	140 Hz
Approval acc. to	KEMA 03 ATEX 1122 X Issue no. 2
Internal capacitance (C.) / inductance (L.)	0 nF / 0 μH
Device designation	⊕ II 1 G Ex ia IIB T6 Ga / II 2 D Ex ia IIIC T85°C Db (max. U _i = 30 V, I _i = 120 mA, P _i = 600 mW)
Design	threaded barrel, M30 x 1.5
Dimensions	64 mm
Housing material	metal, CuZn, chrome-plated
Material active area	Plastic, PA
End cap	Plastic, EPTR
Max. tightening torque housing nut	75 Nm
Connection	cable
Cable quality	5.2 mm, blue, LifYY, PVC, 2 m
Cable cross section	2 x 0.34 mm ²
Vibration resistance	55 Hz (1 mm)
Shock resistance	30 g (11 ms)
Protection class	IP67
MTTF	751 years acc. to SN 29500 (Ed. 99) 40 °C

**Inductive sensor
with analog output
BI15-M30-LI-EXI**

Distance D	60 mm
Distance W	27 mm
Distance T	3 x B
Distance S	45 mm
Distance G	54 mm

Diameter of the active area B Ø 30 mm



**Inductive sensor
with analog output
BI15-M30-LI-EXI**

Accessories

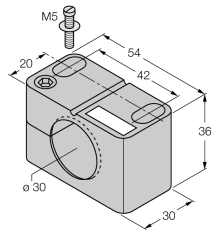
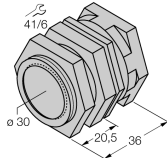
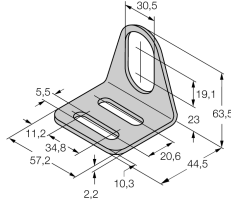
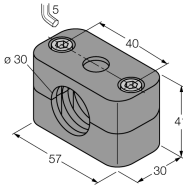
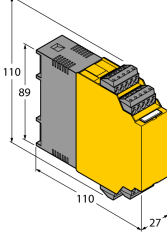
Type code	Ident no.	Description	Dimension drawing
BST-30B	6947216	Fixing clamp for threaded barrel devices, with dead-stop; material: PA6	
QM-30	6945103	Quick-mount bracket with dead-stop; material: Chrome-plated brass Male thread M36 x 1.5. Note: The switching distance of proximity switches can be reduced by the use of quick-mount brackets.	
MW-30	6945005	Mounting bracket for threaded barrel devices; material: Stainless steel A2 1.4301 (AISI 304)	
BSS-30	6901319	Mounting bracket for smooth and threaded barrel devices; material: Polypropylene	
IM33-11EX-HI	7506443	Isolating transducers; 1-port; power supply of 2-wire measuring transducers with HART® communication as well as connection of active 2-wire and passive 3-wire transmitters	

**Inductive sensor
with analog output
BI15-M30-LI-EXI**

TURCK

Industrial
Automation

Accessories

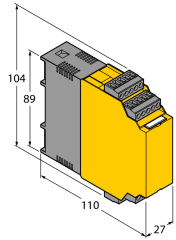
Type code	Ident no.	Description	Dimension drawing
IM43-13-SR	7540041	Limit value monitor; 1-channel; input 0/4...20 mA or 0/2...10 V; supply of 2- or 3-wire transmitters/sensors; limit value adjustment via teach button; three relay outputs with one NO contact each; removable terminal blocks; 27 mm wide; universal voltage supply 20...250 VUC; further limit value monitors are described in our "Interface Technology" catalog.	

Inductive sensor with analog output BI15-M30-LI-EXI

TURCK

Industrial
Automation

Operating manual

Intended use

This device fulfills the directive 94/9/EC and is suited for use in explosion hazardous areas according to EN60079-0:2009, -11:2012, -26:2007. In order to ensure correct operation to the intended purpose it is required to observe the national regulations and directives.

For use in explosion hazardous areas conform to classification

II 1 G and II 2 D (Group II, Category 1 G, electrical equipment for gas-atmospheres and category 2 D, electrical equipment for dust atmospheres)

Marking (see device or technical data sheet)

Ⓔ II 1 G and Ex ia IIB T6 Ga acc. to EN60079 and Ⓔ II 2 D and Ex ia IIIC T100°C Db acc. to EN61241

Local admissible ambient temperature

-25...+65 °C

Installation / Commissioning

These devices may only be installed, connected and operated by trained and qualified staff. Qualified staff must have knowledge of protection classes, directives and regulations concerning electrical equipment designed for use in explosion hazardous areas. Please verify that the classification and the marking on the device comply with the actual application conditions.

This device is only suited for connection to approved Exi circuits compliant to EN60079-0 and -11. Please observe the maximum admissible electrical values.

After connection to other circuits the sensor may no longer be used in Exi installations. When interconnected to (associated) electrical equipment, it is required to perform the "Proof of intrinsic safety" (EN60079-14).

Installation and mounting instructions

Avoid static charging of cables and plastic devices. Please only clean the device with a damp cloth. Do not install the device in a dust flow and avoid build-up of dust deposits on the device.

If the devices and the cable could be subject to mechanical damage, they must be protected accordingly. They must also be shielded against strong electro-magnetic fields.

The pin configuration and the electrical specifications can be taken from the device marking or the technical data sheet.

In order to avoid contamination of the device, please remove possible blanking plugs of the cable glands or connectors only shortly before inserting the cable or opening the cable socket.

service / maintenance

Repairs are not possible. The approval expires if the device is repaired or modified by a person other than the manufacturer. The most important data from the approval are listed.