

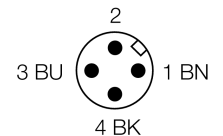

- Threaded barrel, M30 x 1.5
- Plastic, PBT-GF30-V0
- Factor 1 for all metals
- Protection class IP68
- Resistant to magnetic fields
- Extended temperature range
- High switching frequency
- Auto-compensation protects against pre-attenuation
- 3-wire DC, 10...30 VDC
- NO contact, NPN output
- Male M12 x 1

Type code	NI20U-S30-AN6X-H1141
Ident no.	1646620
Rated operating distance Sn	20 mm
Mounting condition	non-flush, partially embeddable
Assured sensing range	≤ (0,81 x Sn) mm
Repeatability	≤ 2 % of full scale
Temperature drift	10 %
	≤ ± 20 %, ≤ -25 °C v ≥ +70 °C
Hysteresis	3...15 %
Ambient temperature	-30...+85 °C
Operating voltage	10...30VDC
Residual ripple	≤ 10 % U _{ss}
DC rated operational current	≤ 200 mA
No-load current I ₀	≤ 15 mA
Residual current	≤ 0.1 mA
Rated insulation voltage	≤ 0.5 kV
Short-circuit protection	yes/ cyclic
Voltage drop at I _e	≤ 1.8 V
Wire breakage / Reverse polarity protection	yes/ complete
Output function	3-wire, NO contact, NPN
Protection class	☐
Switching frequency	1.5 kHz
Design	threaded barrel, M30 x 1.5
Dimensions	62 mm
Housing material	plastic, PBT
Material active area	Plastic, PA
Max. tightening torque housing nut	5 Nm
Connection	male, M12 x 1
Vibration resistance	55 Hz (1 mm)
Shock resistance	30 g (11 ms)
Protection class	IP68
MTTF	874 years acc. to SN 29500 (Ed. 99) 40 °C
Switching state	LED yellow

Wiring diagram

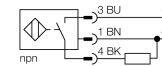

Functional principle

Inductive sensors detect metal objects contactless and wear-free. Due to the patented multicoil system, *uprox*®+ sensors have distinct advantages over conventional sensors. They detect all metals at the same large switching distance and are resistant to magnetic fields.

Distance D	3 x B
Distance W	3 x Sn
Distance T	3 x B
Distance S	0.5 x B
Distance G	6 x Sn
Distance N	2 x Sn
<hr/>	
Diameter of the active area B	Ø 30 mm

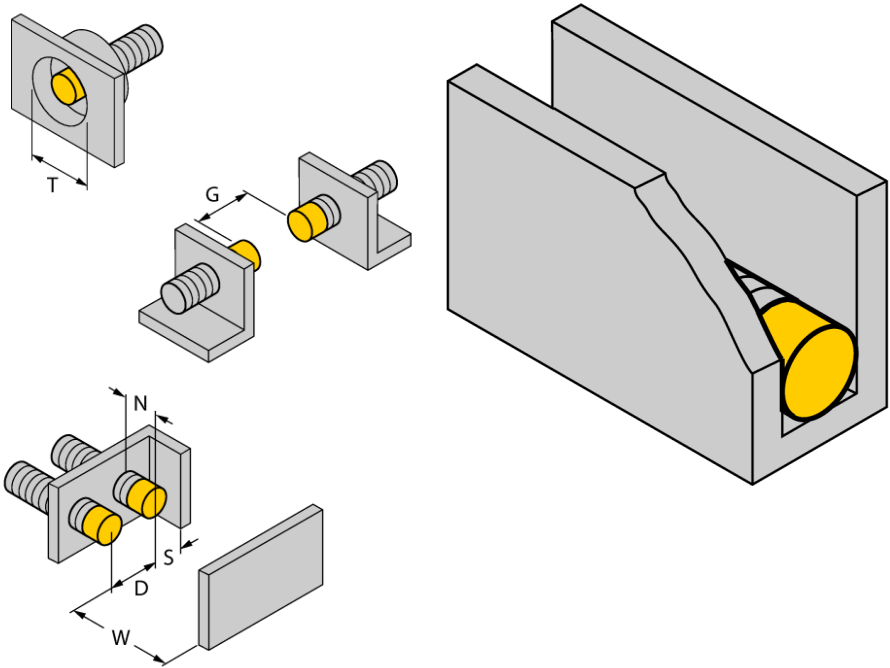

up to 3-side flush mounting possible
 1-side flush mounting: Sr = 15 mm
 2-side flush mounting: Sr = 12 mm
 3-side flush mounting: Sr = 11 mm

Accessories

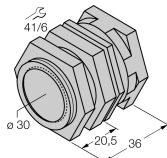
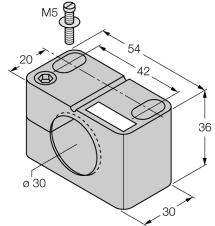
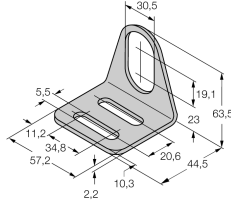
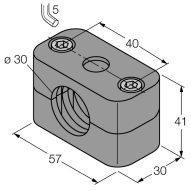
Type code	Ident no.	Description	Dimension drawing
QM-30	6945103	Quick-mount bracket with dead-stop; material: Chrome-plated brass Male thread M36 x 1.5. Note: The switching distance of proximity switches can be reduced by the use of quick-mount brackets.	
BST-30B	6947216	Fixing clamp for threaded barrel devices, with dead-stop; material: PA6	
MW-30	6945005	Mounting bracket for threaded barrel devices; material: Stainless steel A2 1.4301 (AISI 304)	
BSS-30	6901319	Mounting bracket for smooth and threaded barrel devices; material: Polypropylene	

Wiring accessories

Type code	Ident no.	Description	Dimension drawing
RKC4T-2/TEL	6625010	Connection cable, female M12, straight, 3-pin, cable length: 2 m, sheath material: PVC, black; cULus approval; other cable lengths and qualities available, see www.turck.com	