

**Magnetic field sensor
for pneumatic cylinders (magnetic-field immune)
BIM-IKM-AN6X2-H1141/S34**

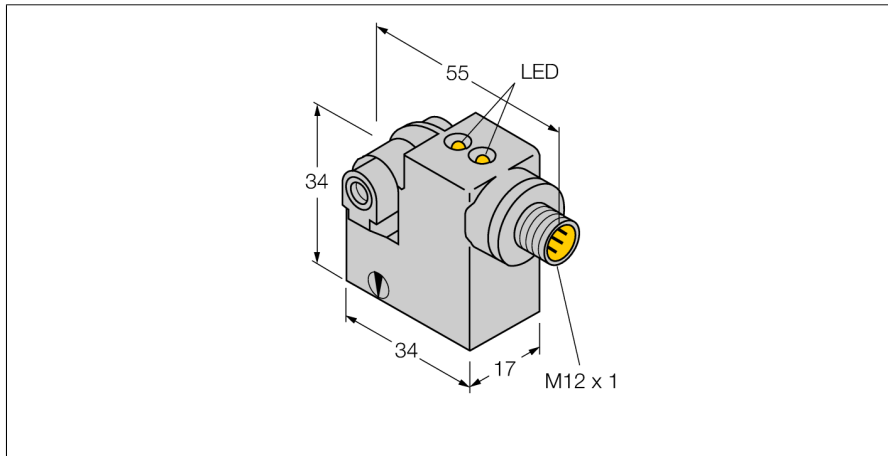

- Rectangular, height 34 mm
- Front active face
- Metal, GD-Zn
- Magnetic-inductive sensor
- Weld resistant to AC fields of 50...60 Hz
- DC 3-wire, 10...30 VDC
- NO contact, NPN output
- Male connector, M12 x 1

Wiring diagram

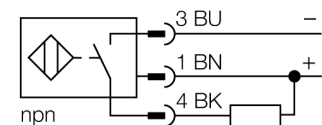

Functional principle







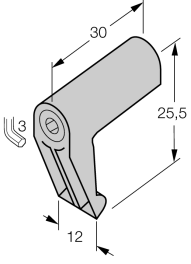

Magnetic field sensors are activated by magnetic fields and are especially suited for piston position detection in pneumatic cylinders. Based on the fact that magnetic fields can permeate non-magnetizable metals, it is possible to detect a permanent magnet attached to the piston through the aluminium wall of the cylinder.

Weld-field immune permprox sensors "freeze" the switching status when detecting a magnetic AC field (50..60 Hz). Consequently, false switching operations are prevented during the welding process. When the AC field disappears, the sensors resume standard operation.

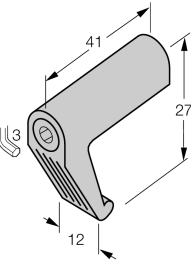
Type code	BIM-IKM-AN6X2-H1141/S34
Ident no.	46273
Pass speed	≤ 1 m/s
Repeatability	≥ ± 0.1 mm
Temperature drift	≤ 0.1 mm
Hysteresis	≤ 1 mm
Ambient temperature	-25...+70 °C
Operating voltage	10...30VDC
Residual ripple	≤ 10 % U _s
DC rated operational current	≤ 200 mA
No-load current I ₀	≤ 15 mA
Residual current	≤ 0.1 mA
Rated insulation voltage	≤ 0.5 kV
Short-circuit protection	yes/ cyclic
Voltage drop at I ₀	≤ 1.8 V
Wire breakage / Reverse polarity protection	yes/ complete
Output function	3-wire, NO contact, NPN
Switching frequency	0.02 kHz
Design	rectangular, IKM
Dimensions	34 x 17 x 34 mm
Housing material	metal, GD-Zn
Material active area	Plastic, PA
Connection	male, M12 x 1
Vibration resistance	55 Hz (1 mm)
Shock resistance	30 g (11 ms)
Protection class	IP67
MTTF	2283 years acc. to SN 29500 (Ed. 99) 40 °C
Mounting on the following profiles	.
Cylindrical design	
Power-on indication	LED green
Switching state	LED yellow

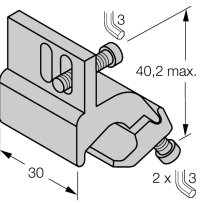

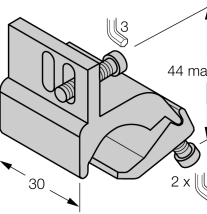
**Magnetic field sensor
for pneumatic cylinders (magnetic-field immune)
BIM-IKM-AN6X2-H1141/S34**

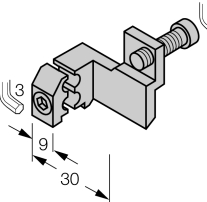
Accessories

Type code	Ident no.	Description	Dimension drawing
KLI 1 KLEMMSTÜCK	69710	Mounting on  tie-rod cylinders; cylinder diameter 32...100 mm; material: Die-cast zinc	
KLI 3 KLEMMSTÜCK	69712	Mounting on  tie-rod cylinders; cylinder diameter 63...160 mm; material: Die-cast zinc	
KLI 5 KLEMMSTÜCK	6971802	Mounting on  profile cylinder; cylinder diameter 32...50 mm; material: Aluminium	
KLI 6 KLEMMSTÜCK	6971805	Mounting on  profile cylinder; cylinder diameter 50...100 mm; material: Aluminium	
KLI 7 KLEMMSTÜCK	6971810	Mounting on  profile cylinder with external dovetail grooves; diameter 32...200 mm; material: Aluminium	

**Magnetic field sensor
for pneumatic cylinders (magnetic-field immune)
BIM-IKM-AN6X2-H1141/S34**

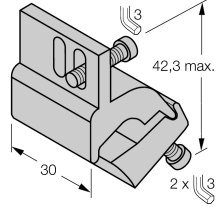
Accessories

Type code	Ident no.	Description	Dimension drawing
CLI 5Z KLEMMSTÜCK	6971803	Mounting on  tie-rod cylinders; cylinder diameter 32...63 mm; material: Aluminum	
CLI 6Z KLEMMSTÜCK	6971806	Mounting on  tie-rod cylinders; cylinder diameter 50...125 mm; material: Aluminum	