

**Magnetic field sensor
for pneumatic cylinders
BIM-QST-AP6X-0,3-RS4T**

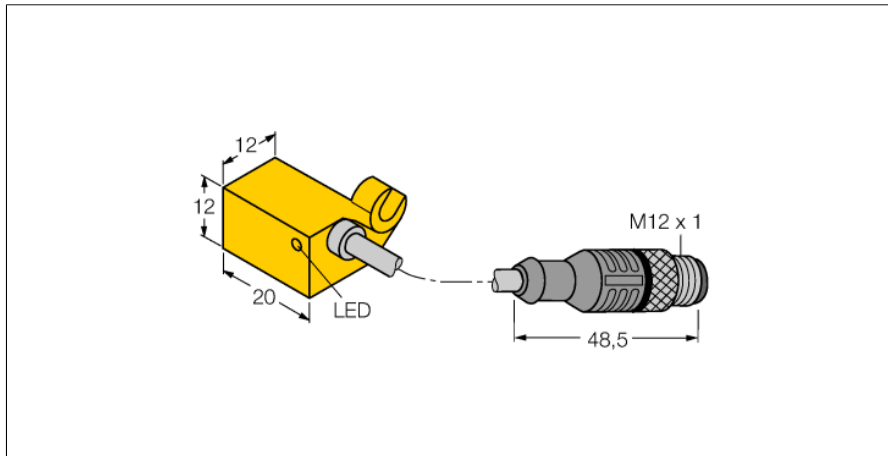

- Rectangular, height 12 mm
- Front active face
- Plastic, PA12-GF30
- Magnetic-inductive sensor
- DC 3-wire, 10...30 VDC
- NO contact, PNP output
- Pigtail with male end, M12 x 1

Wiring diagram

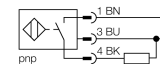

Functional principle

Magnetic field sensors are activated by magnetic fields and are especially suited for piston position detection in pneumatic cylinders. Based on the fact that magnetic fields can permeate non-magnetizable metals, it is possible to detect a permanent magnet attached to the piston through the aluminium wall of the cylinder.







Type code	BIM-QST-AP6X-0,3-RS4T
Ident no.	4688201
Pass speed	≤ 10 m/s
Repeatability	≥ ± 0.1 mm
Temperature drift	≤ 0.1 mm
Hysteresis	≤ 1 mm
Ambient temperature	-25...+70 °C
Operating voltage	10...30VDC
Residual ripple	≤ 10 % U _s
DC rated operational current	≤ 200 mA
No-load current I ₀	≤ 15 mA
Residual current	≤ 0.1 mA
Rated insulation voltage	≤ 0.5 kV
Short-circuit protection	yes/ cyclic
Voltage drop at I ₀	≤ 1.8 V
Wire breakage / Reverse polarity protection	yes/ complete
Output function	3-wire, NO contact, PNP
Switching frequency	1 kHz
Design	rectangular, QST
Dimensions	20 x 12 x 12 mm
Housing material	plastic, PA
Material active area	Plastic, PA
Connection	cable with connector, M12 x 1
Cable quality	4 mm, grey, LifYY, PVC, 0.3 m
Cable cross section	3 x 0.25 mm ²
Vibration resistance	55 Hz (1 mm)
Shock resistance	30 g (11 ms)
Protection class	IP67
MTTF	2283 years acc. to SN 29500 (Ed. 99) 40 °C
Mounting on the following profiles	.
Cylindrical design	
Switching state	LED yellow

**Magnetic field sensor
for pneumatic cylinders
BIM-QST-AP6X-0,3-RS4T**

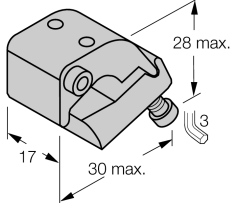
TURCK

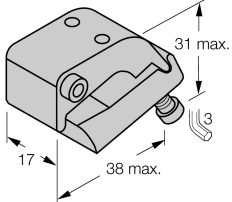
Industrial
Automation

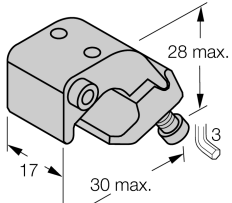
Accessories

Type code	Ident no.	Description	Dimension drawing
KLQ 1-Z KLEMMSTÜCK	6971911	Mounting on  tie-rod cylindes; diameter 32...63 mm, material: Anodized aluminium; please order fixing clamp separately	
KLQ 2-Z KLEMMSTÜCK	6971912	Mounting on  tie-rod cylindes; diameter 50...125 mm, material: Anodized aluminium; please order fixing clamp separately	
KLQ 1 KLEMMSTÜCK	6971901	Mounting on  profile cylinders; cylinder diameter 32...50 mm, material: Anodized aluminium; please order fixing clamp separately	
KLQ 2 KLEMMSTÜCK	6971902	Mounting on  profile cylinders; cylinder diameter 50...100 mm, material: Anodized aluminium; please order fixing clamp separately	