

**Ultrasonic sensor  
diffuse mode sensor  
RU100U-M18M-UP8X2-H1151**

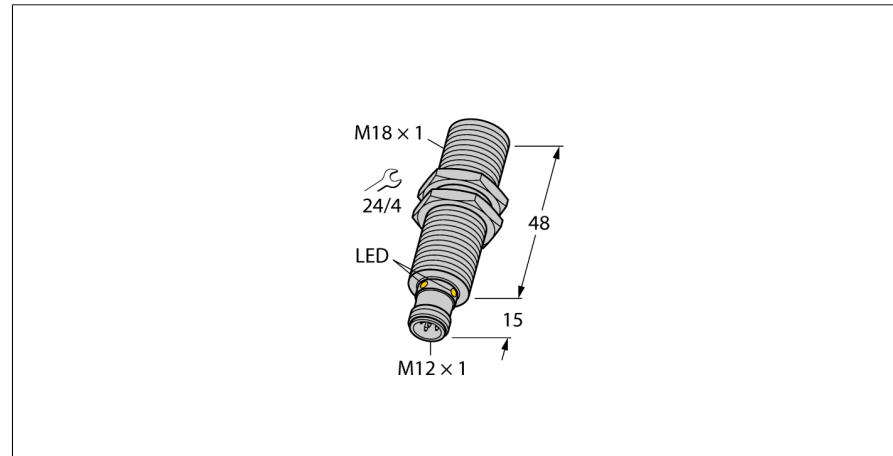

- Smooth sonic transducer face
- Cylindrical housing M18
- Connection via male M12 x 1
- Switchpoint adjustable via Easy-Teach
- Temperature compensation
- Blind zone: 15 cm
- Range: 100 cm
- Resolution: 1 mm
- Aperture angle of sonic cone: 16 °
- 1 x switching output, PNP
- NO/NC programmable

**Wiring diagram**

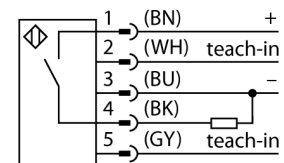

**Functional principle**

Ultrasonic sensors use ultrasonic waves for non-contact and wear-free detection of many objects. Regardless of whether the object is transparent or opaque, metallic or non-metallic, or of liquid, solid or powdery consistency. Even environmental conditions such as spray, dust or rain hardly affect their function.

**Characteristic**

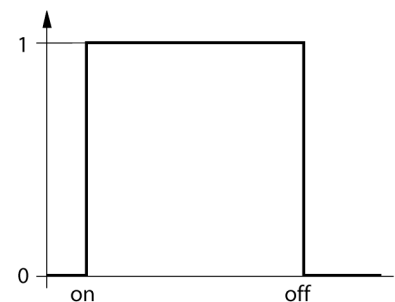

<b>Type code</b>	RU100U-M18M-UP8X2-H1151
Ident no.	1610010
<b>Design</b>	cylindrical/threaded, M18
Dimensions	Ø18 x 63 mm
Housing material	metal, CuZn, nickel-plated
Sonic converter material	plastic, PBT
Connection	male, M12 x 1, 5-wire
Protection class	IP67
Ambient temperature	-25...+70 °C
Storage temperature	-40...+80 °C
Declaration of conformity EN ISO/IEC	EN 60947-5-2
Vibration resistance	IEC 60068-2
MTTF	195 years
MTTF note	acc. to SN 29500 (Ed. 99) 40 °C
<b>Switching state</b>	LED green / yellow
<b>Residual ripple</b>	10 % U <sub>s</sub>
Operating voltage	15...30VDC
DC rated operational current	≤ 150 mA
No-load current I <sub>0</sub>	≤ 50 mA
Load resistance	≤ 1000 Ω
Response time	65 ms
Readiness delay	300 ms
Output function	NO/NC , PNP
Output 1	switching output
Switching frequency	8 Hz
Hysteresis	≤ 5 % of full scale
Voltage drop at I <sub>0</sub>	≤ 2.5 V
Short-circuit protection	yes/ cyclic
Reverse polarity protection	yes
Wire breakage protection	yes
<b>Operating mode</b>	diffuse mode ultrasonic sensor
Range	15...100 cm
Resolution	1 mm
minimum switching range	10 mm
Ultrasound frequency	200 kHz
Repeatability	0.15 % of full scale
Temperature drift	1.5% of full scale
Linearity error	≤ ± 0.5 %
Edge lengths of the nominal actuator	100 mm
Approach speed	≤ 8 m/s
Pass speed	≤ 1.5 m/s

**Ultrasonic sensor  
diffuse mode sensor  
RU100U-M18M-UP8X2-H1151**

**TURCK**

Industrial  
Automation

Mounting instructions / Description

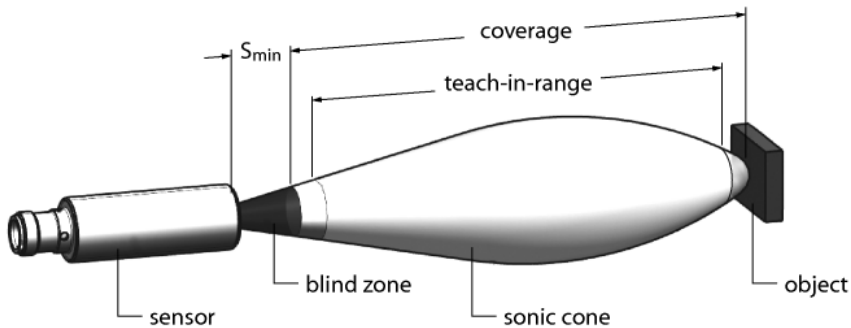

**Settings**

The ultrasonic sensor features a switching output with adjustable switchpoint. Object presence is signalled by the green and yellow LED.

One switchpoint is taught. This must be within the detection range. In this operating mode the background is suppressed.

**Via Easy-Teach adapter**

- Connect the teach adapter TX1-Q20L60 between sensor and connection cable
- Place object at the end of the switching range
- Press and hold button for at least 2 to 7 s against Gnd

After successful teach-in the sensor automatically runs in standard operating mode. Unsuccessful teach-in is signalled by the LED flashing slowly at a frequency of 5 Hz.

**LED response**

In standard operating mode both LEDs signal the switching states of the sensor.

- green: Object is in the detection range but not in the switching range
- yellow: Object is in the switching range
- off: Object is outside the detection range

**Ultrasonic sensor  
diffuse mode sensor  
RU100U-M18M-UP8X2-H1151**

**Accessories**

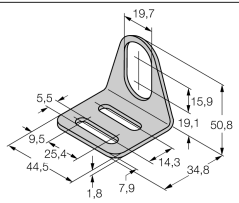
Type code	Ident no.	Description	Dimension drawing
MW-18	6945004	Mounting bracket for threaded barrel devices; material: Stainless steel A2 1.4301 (AISI 304)	

**Wiring accessories**

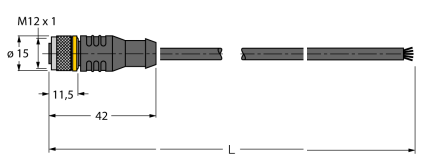
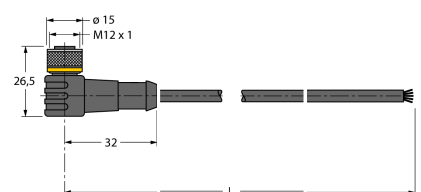
Type code	Ident no.	Description	Dimension drawing
RKC4.5T-2/TEL	6625016	Connection cable, female M12, straight, 5-pin, cable length: 2 m, sheath material: PVC, black; cULus approval; other cable lengths and qualities available, see <a href="http://www.turck.com">www.turck.com</a>	
WKC4.5T-2/TEL	6625028	Connection cable, female M12, angled, 5-pin, cable length: 2 m, sheath material: PVC, black; cULus approval; other cable lengths and qualities available, see <a href="http://www.turck.com">www.turck.com</a>	

**Function accessories**

Type code	Ident no.	Description	Dimension drawing
TX1-Q20L60	6967114	Teach adapter for inductive encoders, linear position, angle and ultrasonic sensors	