

**Ultrasonic sensor
diffuse mode sensor
S18UUAQ**

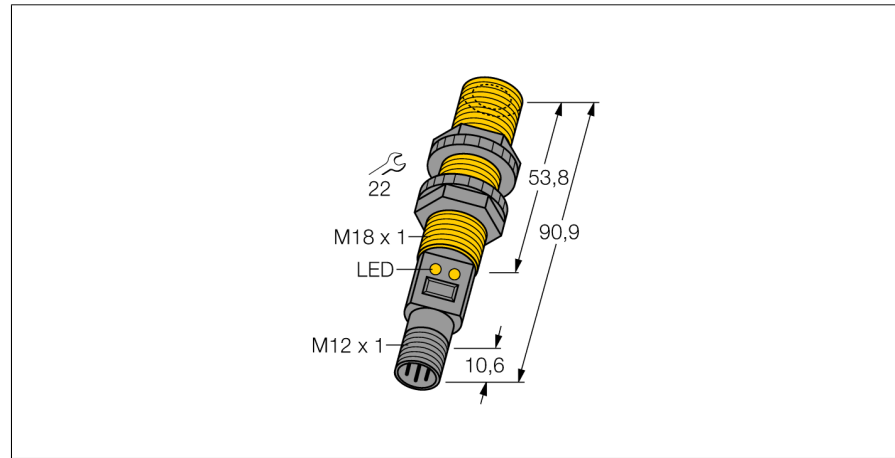

- Compact design
- Connection via male M12 x 1
- Temperature compensation
- Very small blind zone
- Measuring range adjustable via teach-in

Wiring diagram

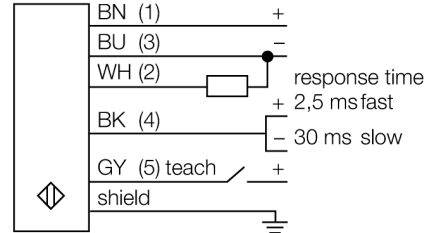

Functional principle

Ultrasonic sensors detect a multitude of objects contactless and wear-free with ultrasonic waves. Regardless of whether the object is transparent or opaque, metallic or non-metallic, liquid, solid or powdery. Even environmental conditions such as spray, dust or rain hardly affect their function.

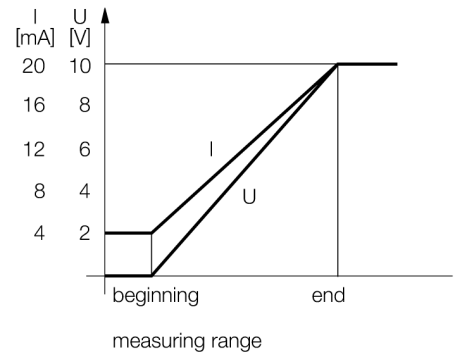

Type code	S18UUAQ
Ident no.	3002700
Design	cylindrical/threaded, S18U
Dimensions	Ø18 x 90.9 mm
Housing material	plastic, PBT
Connection	male, M12 x 1
Protection class	IP67
Ambient temperature	-20...+60 °C
MTTF	53 years
MTTF note	acc. to SN 29500 (Ed. 99) 40 °C
Power-on indication	LED
Switching state	LED
Operating voltage	10...30VDC
No-load current I ₀	≤ 100 mA
Response time	3 ms
Voltage output	0...10V
Short-circuit protection	yes
Reverse polarity protection	complete
Wire breakage protection	yes
Operating mode	diffuse mode ultrasonic sensor
Range	3...30 cm
Ultrasound frequency	300 kHz
Repeatability	≥ ± 0.25 mm
Edge lengths of the nominal actuator	50 mm

**Ultrasonic sensor
diffuse mode sensor
S18UUAQ**

Accessories

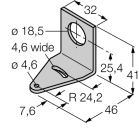
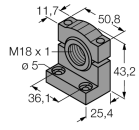
Type code	Ident no.	Description	Dimension drawing
SMB18A	3033200	Mounting bracket, stainless steel, for sensors with 18 mm thread	
SMB18FM	3079421	mounting bracket, black, M22 x1.5 mm, male thread, female thread M18 x 1, for sensors with 18 mm thread	
SMB18SF	3052519	Mounting bracket, PTB black steel, for sensors with 18 mm thread	

Wiring accessories

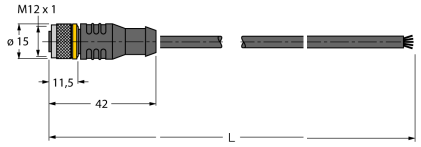
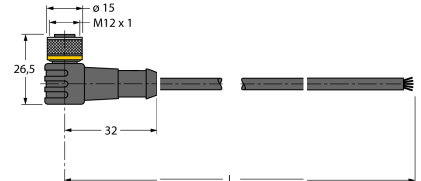
Type code	Ident no.	Description	Dimension drawing
RKC4.5T-2/TEL	6625016	Connection cable, female M12, straight, 5-pin, cable length: 2 m, sheath material: PVC, black; cULus approval; other cable lengths and qualities available, see www.turck.com	
WKC4.5T-2/TEL	6625028	Connection cable, female M12, angled, 5-pin, cable length: 2 m, sheath material: PVC, black; cULus approval; other cable lengths and qualities available, see www.turck.com	

Ultrasonic sensor
diffuse mode sensor
S18UUAQ

TURCK

Industrial
Automation

Function accessories

Type code	Ident no.	Description	Dimension drawing
UWG18-6.4	3076952	Ultrasonic focussing-adapter for QS18U and S18U, internal diameter 6.4 mm	
UWG18-5.0	3077342	Ultrasonic focussing-adapter for QS18U and S18U, internal diameter 5.0 mm	