

**Ultrasonic sensor
diffuse mode sensor
T30UIPAQ**

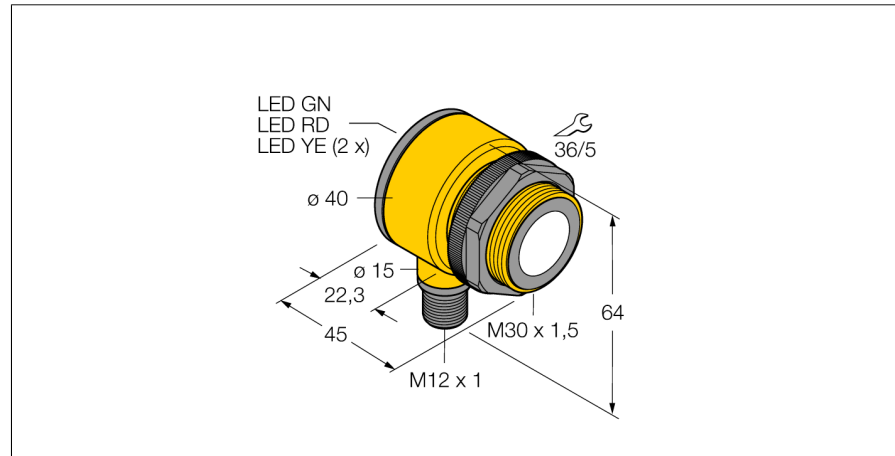

- Compact design
- Connection via male M12 x 1
- Operating voltage 15...24 VDC
- PNP transistor output and analog output for current
- Measuring range adjustable via teach-in

Wiring diagram

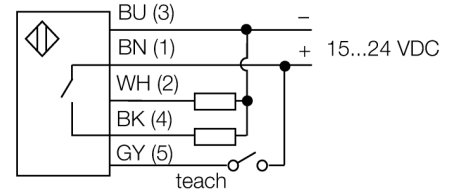

Functional principle

Ultrasonic sensors detect a multitude of objects contactless and wear-free with ultrasonic waves. Regardless of whether the object is transparent or opaque, metallic or non-metallic, liquid, solid or powdery. Even environmental conditions such as spray, dust or rain hardly affect their function.

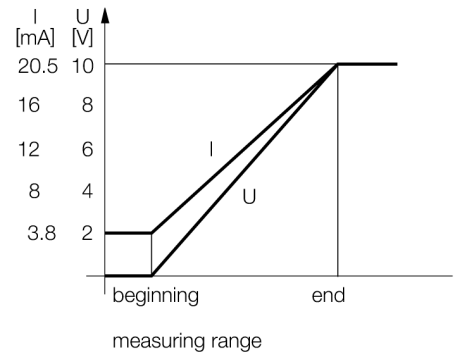

Type code	T30UIPAQ
Ident no.	3055975
Design	cylindrical/threaded, T30
Dimensions	Ø40 x 45 mm
Housing material	plastic, Polyester
Connection	male, M12 x 1
Protection class	IP67
Ambient temperature	-20...+70 °C
MTTF	246 years
MTTF note	acc. to SN 29500 (Ed. 99) 40 °C
Power-on indication	LED
Switching state	LED yellow
Operating voltage	15...24VDC
DC rated operational current	≤ 150 mA
No-load current I ₀	≤ 50 mA
Output function	NO contact, PNP/analog output
Current output	4...20mA
Switching frequency	20 Hz
Hysteresis	≤ 2.5 mm
Voltage drop at I ₀	≤ 1.5 V
Short-circuit protection	yes/ cyclic
Reverse polarity protection	complete
Wire breakage protection	yes
Operating mode	diffuse mode ultrasonic sensor
Range	15...100 cm
Ultrasound frequency	230 kHz
Repeatability	≥ ± 0.375 mm

**Ultrasonic sensor
diffuse mode sensor
T30UIPAQ**

Accessories

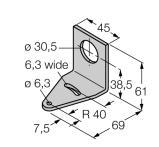
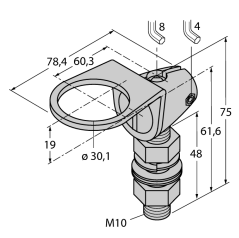
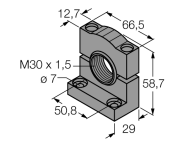
Type code	Ident no.	Description	Dimension drawing
SMB30A	3032723	Mounting bracket, stainless steel, for sensors with 30 mm thread	
SMB30FAM10	3011185	Mounting bracket, stainless steel, for M10 x 1.5 thread, thread length 30 mm	
SMB30SC	3052521	Mounting bracket, PBT black; for 30 mm thread; with 4 screws M5 x 0.8	

Wiring accessories

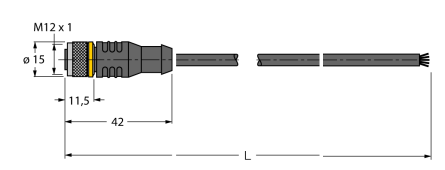
Type code	Ident no.	Description	Dimension drawing
RKC4.5T-2/TEL	6625016	Connection cable, female M12, straight, 5-pin, cable length: 2 m, sheath material: PVC, black; cULus approval; other cable lengths and qualities available, see www.turck.com	
WKC4.5T-2/TEL	6625028	Connection cable, female M12, angled, 5-pin, cable length: 2 m, sheath material: PVC, black; cULus approval; other cable lengths and qualities available, see www.turck.com	