

**Ultrasonic sensor  
diffuse mode sensor  
T30UUPAQ**

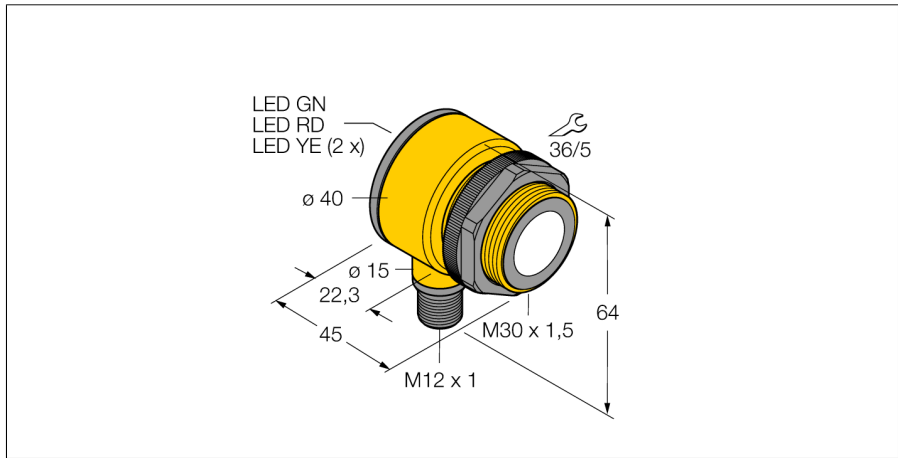

- Compact design
- Connection via male M12 x 1
- Operating voltage 15...24 VDC
- PNP transistor output and analog output for voltage
- Measuring range adjustable via teach-in

**Wiring diagram**

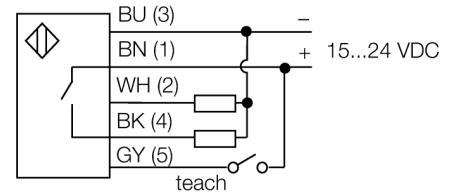

**Functional principle**

Ultrasonic sensors detect a multitude of objects contactless and wear-free with ultrasonic waves. Regardless of whether the object is transparent or opaque, metallic or non-metallic, liquid, solid or powdery. Even environmental conditions such as spray, dust or rain hardly affect their function.

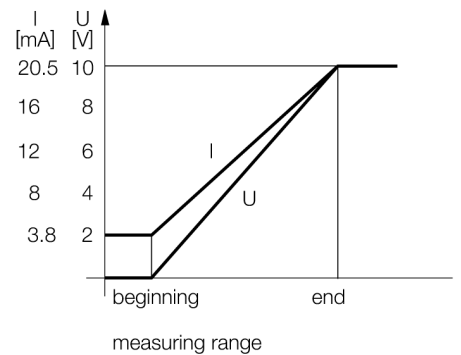

<b>Type code</b>	T30UUPAQ
Ident no.	3055987
<b>Design</b>	cylindrical/threaded, T30
Dimensions	Ø40 x 45 mm
Housing material	plastic, Polyester
Connection	male, M12 x 1
Protection class	IP67
Ambient temperature	-20...+70 °C
MTTF	246 years
MTTF note	acc. to SN 29500 (Ed. 99) 40 °C
<b>Power-on indication</b>	LED
Switching state	LED yellow
<b>Operating voltage</b>	15...24VDC
Output function	NO contact, PNP/analog output
Voltage output	0...10V
Switching frequency	20 Hz
Hysteresis	≤ 2.5 mm
<b>Operating mode</b>	diffuse mode ultrasonic sensor
Range	15...100 cm
Ultrasound frequency	230 kHz
Repeatability	≥ ± 0.375 mm

**Ultrasonic sensor  
diffuse mode sensor  
T30UUPAQ**

**Accessories**

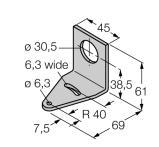
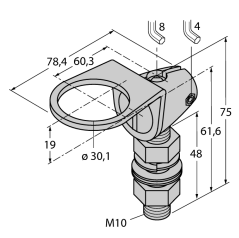
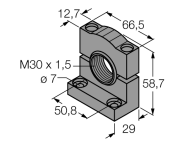
Type code	Ident no.	Description	Dimension drawing
SMB30A	3032723	Mounting bracket, stainless steel, for sensors with 30 mm thread	
SMB30FAM10	3011185	Mounting bracket, stainless steel, for M10 x 1.5 thread, thread length 30 mm	
SMB30SC	3052521	Mounting bracket, PBT black; for 30 mm thread; with 4 screws M5 x 0.8	

**Wiring accessories**

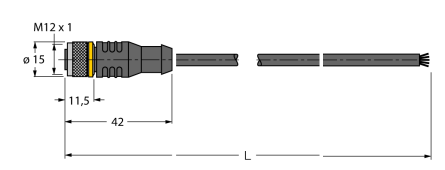
Type code	Ident no.	Description	Dimension drawing
RKC4.5T-2/TEL	6625016	Connection cable, female M12, straight, 5-pin, cable length: 2 m, sheath material: PVC, black; cULus approval; other cable lengths and qualities available, see <a href="http://www.turck.com">www.turck.com</a>	
WKC4.5T-2/TEL	6625028	Connection cable, female M12, angled, 5-pin, cable length: 2 m, sheath material: PVC, black; cULus approval; other cable lengths and qualities available, see <a href="http://www.turck.com">www.turck.com</a>	