

**Ultrasonic sensor
diffuse mode sensor
T30UXUAQ8**

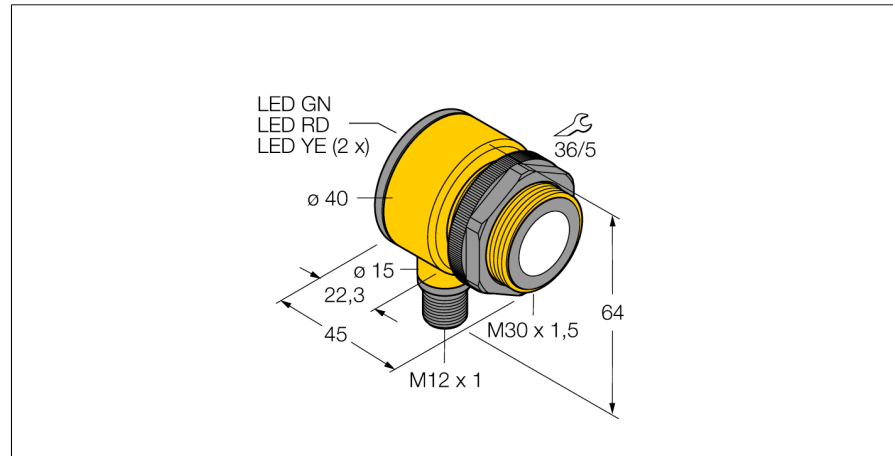

- Compact design
- Cable with male end M12 x 1, 4-pin
- Analog output 0...10 V
- Response time adjustable
- Integrated temperature compensation
- Measuring range adjustable via teach-in

Wiring diagram

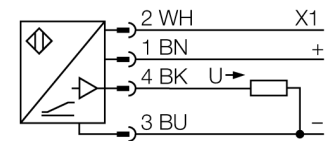

Functional principle

Ultrasonic sensors detect a multitude of objects contactless and wear-free with ultrasonic waves. Regardless of whether the object is transparent or opaque, metallic or non-metallic, liquid, solid or powdery. Even environmental conditions such as spray, dust or rain hardly affect their function.

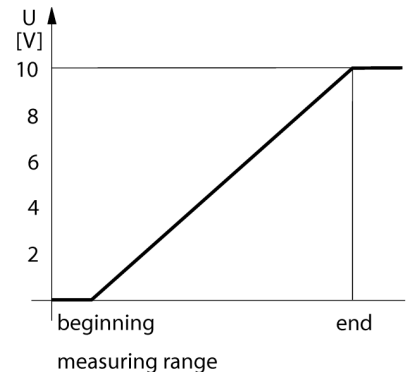

Type code	T30UXUAQ8
Ident no.	3080465
Design	cylindrical/threaded, T30U
Dimensions	Ø40 x 45 mm
Housing material	plastic, Polyester
Connection	male, M12 x 1
Protection class	IP67
Ambient temperature	-40...+70 °C
Power-on indication	LED
Operating voltage	10...30VDC
Response time	45 ms
Voltage output	0...10V
Hysteresis	≤ 2 mm
Short-circuit protection	yes/ cyclic
Reverse polarity protection	complete
Wire breakage protection	yes
Operating mode	diffuse mode ultrasonic sensor
Range	10...100 cm
Ultrasound frequency	224 kHz
Repeatability	≥ ± 0.5 mm
Edge lengths of the nominal actuator	100 mm

**Ultrasonic sensor
diffuse mode sensor
T30UXUAQ8**

TURCK

Industrial
Automation

Accessories

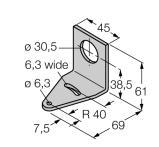
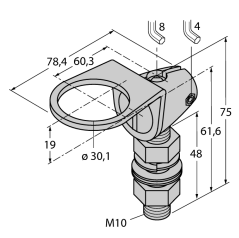
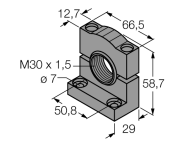
Type code	Ident no.	Description	Dimension drawing
SMB30A	3032723	Mounting bracket, stainless steel, for sensors with 30 mm thread	
SMB30FAM10	3011185	Mounting bracket, stainless steel, for M10 x 1.5 thread, thread length 30 mm	
SMB30SC	3052521	Mounting bracket, PBT black; for 30 mm thread; with 4 screws M5 x 0.8	

Wiring accessories

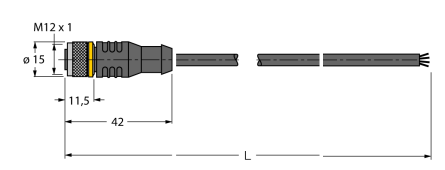
Type code	Ident no.	Description	Dimension drawing
RKC4.4T-2/TEL	6625013	Connection cable, female M12, straight, 4-pin, cable length: 2 m, sheath material: PVC, black; cULus approval; other cable lengths and qualities available, see www.turck.com	
WKC4.4T-2/TEL	6625025	Connection cable, female M12, angled, 4-pin, cable length: 2 m, sheath material: PVC, black; cULus approval; other cable lengths and qualities available, see www.turck.com	