

**Ultrasonic sensor  
diffuse mode sensor  
T30UXUBQ8**

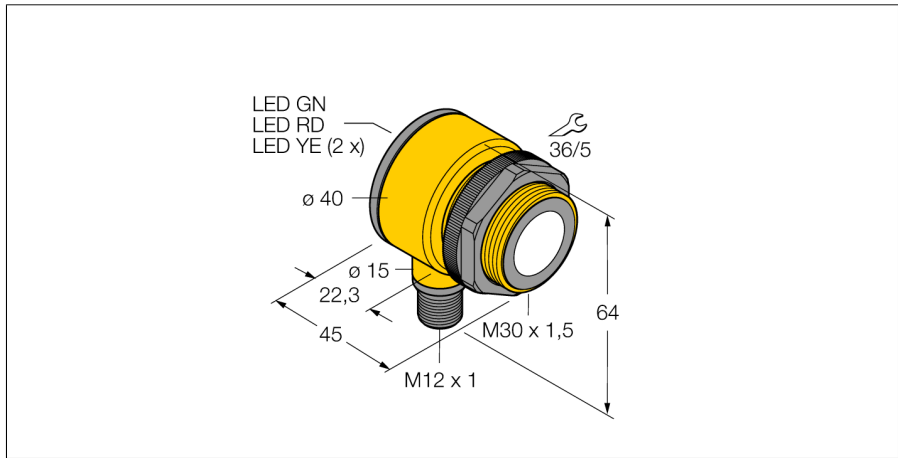

- Compact design
- Cable with male end M12 x 1, 4-pin
- Analog output 0...10 V
- Response time adjustable
- Integrated temperature compensation
- Measuring range adjustable via teach-in

**Wiring diagram**

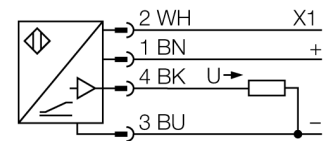

**Functional principle**

Ultrasonic sensors detect a multitude of objects contactless and wear-free with ultrasonic waves. Regardless of whether the object is transparent or opaque, metallic or non-metallic, liquid, solid or powdery. Even environmental conditions such as spray, dust or rain hardly affect their function.

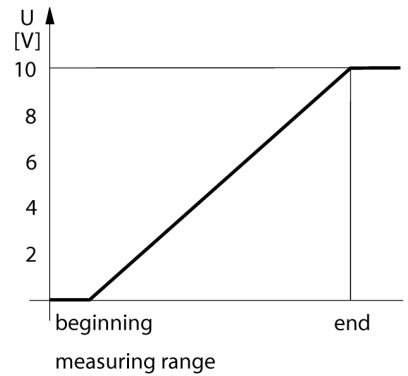

<b>Type code</b>	T30UXUBQ8
Ident no.	3080471
<b>Design</b>	cylindrical/threaded, T30U
Dimensions	Ø40 x 45 mm
Housing material	plastic, Polyester
Connection	male, M12 x 1
Protection class	IP67
Ambient temperature	-40...+70 °C
<b>Power-on indication</b>	LED
<b>Operating voltage</b>	10...30VDC
Response time	92 ms
Voltage output	0...10V
Hysteresis	≤ 3 mm
Short-circuit protection	yes/ cyclic
Reverse polarity protection	complete
Wire breakage protection	yes
<b>Operating mode</b>	diffuse mode ultrasonic sensor
Range	20...200 cm
Ultrasound frequency	174 kHz
Repeatability	≥ ± 1 mm
Edge lengths of the nominal actuator	100 mm

**Ultrasonic sensor  
diffuse mode sensor  
T30UXUBQ8**

**TURCK**

Industrial  
Automation

**Accessories**

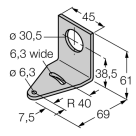
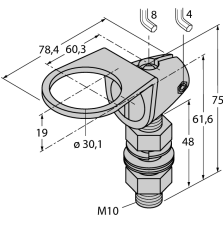
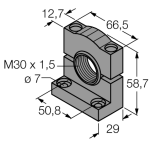
Type code	Ident no.	Description	Dimension drawing
SMB30A	3032723	Mounting bracket, stainless steel, for sensors with 30 mm thread	
SMB30FAM10	3011185	Mounting bracket, stainless steel, for M10 x 1.5 thread, thread length 30 mm	
SMB30SC	3052521	Mounting bracket, PBT black; for 30 mm thread; with 4 screws M5 x 0.8	

**Wiring accessories**

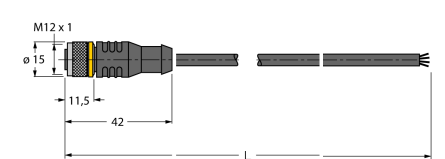
Type code	Ident no.	Description	Dimension drawing
RKC4.4T-2/TEL	6625013	Connection cable, female M12, straight, 4-pin, cable length: 2 m, sheath material: PVC, black; cULus approval; other cable lengths and qualities available, see <a href="http://www.turck.com">www.turck.com</a>	
WKC4.4T-2/TEL	6625025	Connection cable, female M12, angled, 4-pin, cable length: 2 m, sheath material: PVC, black; cULus approval; other cable lengths and qualities available, see <a href="http://www.turck.com">www.turck.com</a>	