

**Ultrasonic sensor
diffuse mode sensor
T30UXUCQ8**

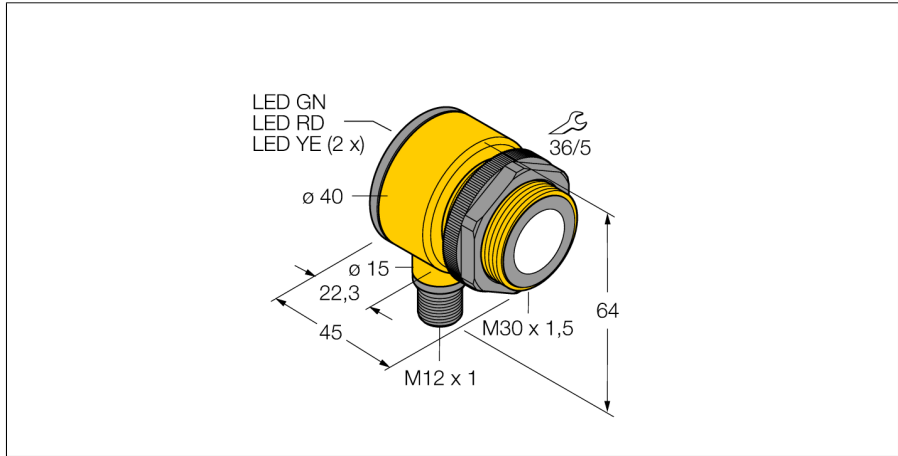

- Compact design
- Cable with male end M12 x 1, 4-pin
- Analog output 0...10 V
- Response time adjustable
- Integrated temperature compensation
- Measuring range adjustable via teach-in

Wiring diagram

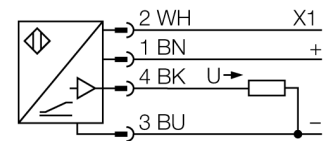

Functional principle

Ultrasonic sensors detect a multitude of objects contactless and wear-free with ultrasonic waves. Regardless of whether the object is transparent or opaque, metallic or non-metallic, liquid, solid or powdery. Even environmental conditions such as spray, dust or rain hardly affect their function.

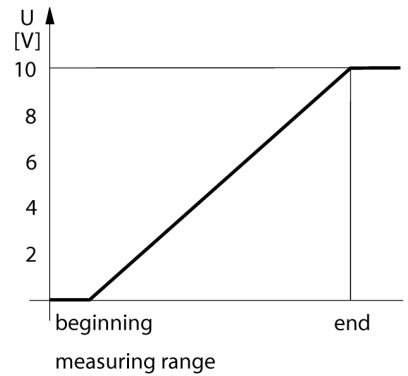

| | |
|--------------------------------------|--------------------------------|
| Type code | T30UXUCQ8 |
| Ident no. | 3080476 |
| Design | cylindrical/threaded, T30U |
| Dimensions | Ø40 x 45 mm |
| Housing material | plastic, Polyester |
| Connection | male, M12 x 1 |
| Protection class | IP67 |
| Ambient temperature | -40...+70 °C |
| Power-on indication | LED |
| Operating voltage | 10...30VDC |
| Response time | 135 ms |
| Voltage output | 0...10V |
| Hysteresis | ≤ 4 mm |
| Short-circuit protection | yes/ cyclic |
| Reverse polarity protection | complete |
| Wire breakage protection | yes |
| Operating mode | diffuse mode ultrasonic sensor |
| Range | 30...300 cm |
| Ultrasound frequency | 114 kHz |
| Repeatability | ≥ ± 1.5 mm |
| Edge lengths of the nominal actuator | 100 mm |

**Ultrasonic sensor
diffuse mode sensor
T30UXUCQ8**

Accessories

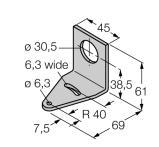
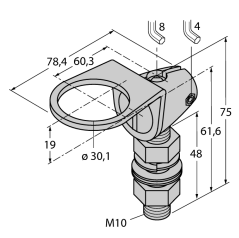
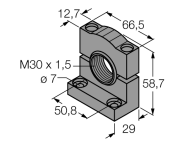
| Type code | Ident no. | Description | Dimension drawing |
|------------|-----------|--|---|
| SMB30A | 3032723 | Mounting bracket, stainless steel, for sensors with 30 mm thread |  |
| SMB30FAM10 | 3011185 | Mounting bracket, stainless steel, for M10 x 1.5 thread, thread length 30 mm |  |
| SMB30SC | 3052521 | Mounting bracket, PBT black; for 30 mm thread; with 4 screws M5 x 0.8 |  |

Wiring accessories

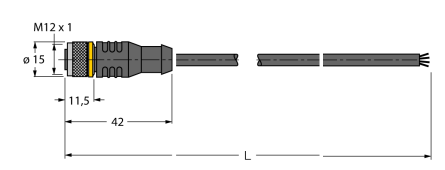
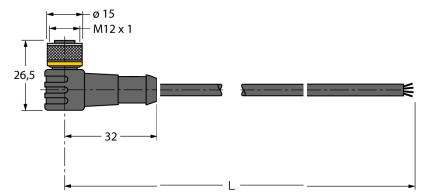
| Type code | Ident no. | Description | Dimension drawing |
|---------------|-----------|--|---|
| RKC4.4T-2/TEL | 6625013 | Connection cable, female M12, straight, 4-pin, cable length: 2 m, sheath material: PVC, black; cULus approval; other cable lengths and qualities available, see www.turck.com |  |
| WKC4.4T-2/TEL | 6625025 | Connection cable, female M12, angled, 4-pin, cable length: 2 m, sheath material: PVC, black; cULus approval; other cable lengths and qualities available, see www.turck.com |  |