

**Ultrasonic sensor
diffuse mode sensor
T30UXIAQ8**

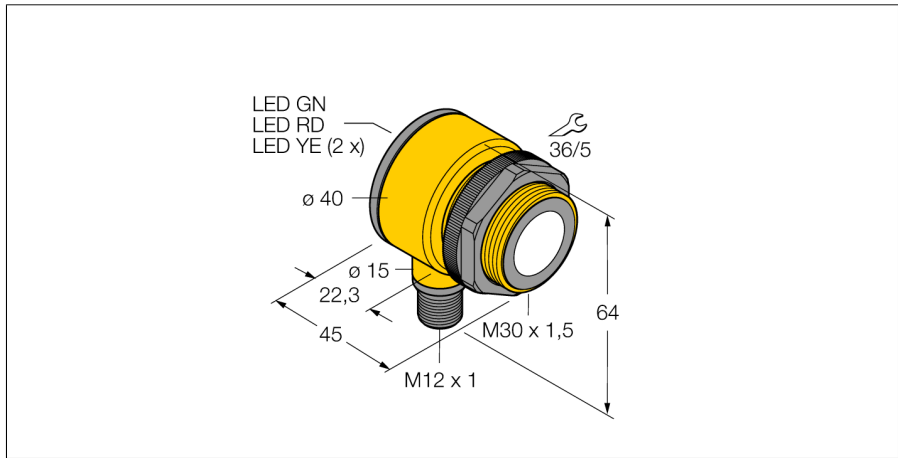

- Compact design
- Cable with male end M12 x 1, 4-pin
- Analog output 4...20 mA
- Response time adjustable
- Integrated temperature compensation
- Measuring range adjustable via teach-in

Wiring diagram

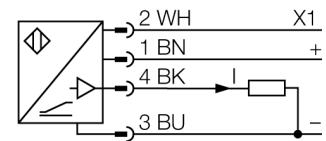

Functional principle

Ultrasonic sensors detect a multitude of objects contactless and wear-free with ultrasonic waves. Regardless of whether the object is transparent or opaque, metallic or non-metallic, liquid, solid or powdery. Even environmental conditions such as spray, dust or rain hardly affect their function.

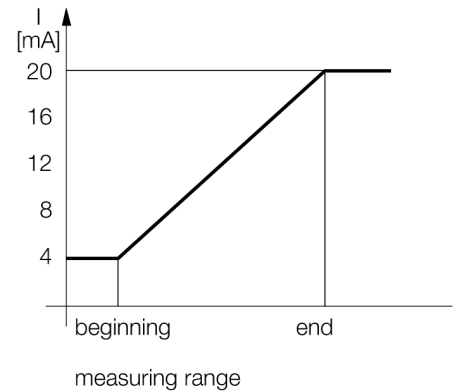

Type code	T30UXIAQ8
Ident no.	3080481
Design	cylindrical/threaded, T30U
Dimensions	Ø40 x 45 mm
Housing material	plastic, Polyester
Connection	male, M12 x 1
Protection class	IP67
Ambient temperature	-40...+70 °C
Power-on indication	LED
Operating voltage	10...30VDC
Load resistance	≤ 1000 Ω
Response time	45 ms
Current output	4...20mA
Hysteresis	≤ 2 mm
Short-circuit protection	yes/ cyclic
Reverse polarity protection	complete
Wire breakage protection	yes
Operating mode	diffuse mode ultrasonic sensor
Range	10...100 cm
Ultrasound frequency	224 kHz
Repeatability	≥ ± 0.5 mm
Edge lengths of the nominal actuator	100 mm

**Ultrasonic sensor
diffuse mode sensor
T30UXIAQ8**

Accessories

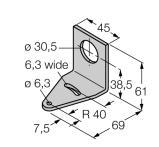
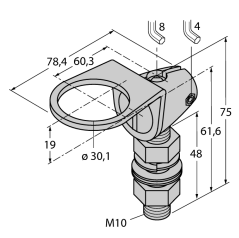
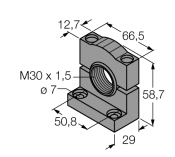
Type code	Ident no.	Description	Dimension drawing
SMB30A	3032723	Mounting bracket, stainless steel, for sensors with 30 mm thread	
SMB30FAM10	3011185	Mounting bracket, stainless steel, for M10 x 1.5 thread, thread length 30 mm	
SMB30SC	3052521	Mounting bracket, PBT black; for 30 mm thread; with 4 screws M5 x 0.8	

Wiring accessories

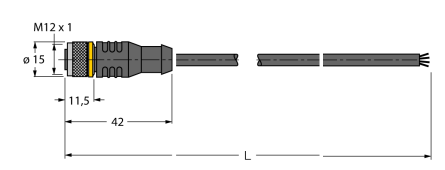
Type code	Ident no.	Description	Dimension drawing
RKC4.4T-2/TEL	6625013	Connection cable, female M12, straight, 4-pin, cable length: 2 m, sheath material: PVC, black; cULus approval; other cable lengths and qualities available, see www.turck.com	
WKC4.4T-2/TEL	6625025	Connection cable, female M12, angled, 4-pin, cable length: 2 m, sheath material: PVC, black; cULus approval; other cable lengths and qualities available, see www.turck.com	