

**Ultrasonic sensor
diffuse mode sensor
QS18UPAEQ8**

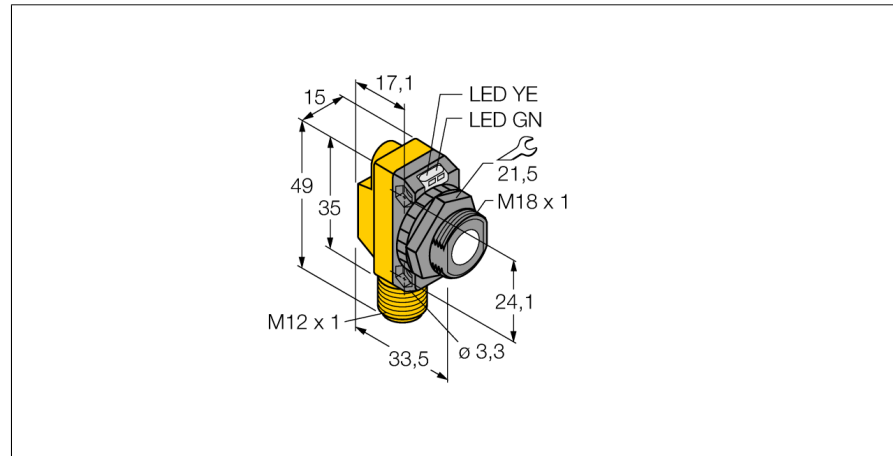

- Operating voltage 12...30 VDC
- Compact design
- Male, M12 x 1
- Switching range adjustable via teach-connection
- Adjustable to retroreflective mode

Wiring diagram

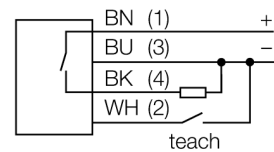

Type code	QS18UPAEQ8
Ident no.	3073166
Design	rectangular, QS18U
Housing material	plastic, ABS
Sonic converter material	plastic, Epoxyd resin and PU foam
Connection	male, M12 x 1
Protection class	IP68
Ambient temperature	-20...+60 °C
Power-on indication	LED
Switching state	LED
Operating voltage	12...30VDC
No-load current I ₀	≤ 25 mA
Output function	NO contact, PNP
Switching frequency	33 Hz
Hysteresis	≤ 1.4 mm
Short-circuit protection	yes
Reverse polarity protection	complete
Wire breakage protection	yes
Operating mode	diffuse mode ultrasonic sensor
Range	5...50 cm
Ultrasound frequency	300 kHz
Repeatability	≥ ± 0.7 mm
Edge lengths of the nominal actuator	50 mm

Functional principle

Ultrasonic sensors detect a multitude of objects contactless and wear-free with ultrasonic waves. Regardless of whether the object is transparent or opaque, metallic or non-metallic, liquid, solid or powdery. Even environmental conditions such as spray, dust or rain hardly affect their function.

**Ultrasonic sensor
diffuse mode sensor
QS18UPAEQ8**

TURCK

Industrial
Automation

Accessories

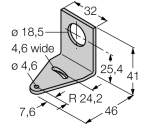
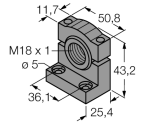
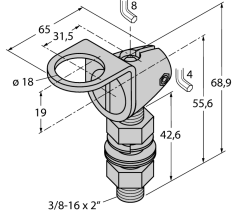
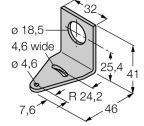
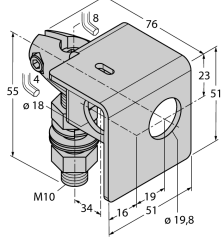
Type code	Ident no.	Description	Dimension drawing
SMB18A	3470200	Mounting bracket, stainless steel, for sensors with 18 mm thread	
SMB18SF	3052519	Mounting bracket, PTB black steel, for sensors with 18 mm thread	
SMB18FA	3074004	Mounting bracket; material VA 1.4401, for 18 mm thread	
SMB18FM	3079421	mounting bracket, black, M22 x1.5 mm, male thread, female thread M18 x 1, for sensors with 18 mm thread	
SMB18UR	3052517	Mounting bracket, for wall mounting, stainless steel 300, 2-piece, rotatable, 18 mm bore hole, srew set included	
SMB18A	3033200	Mounting bracket, stainless steel, for sensors with 18 mm thread	
SMB18AFAM10	3012558	Mounting bracket, material VA 1.4401, for M10 x 1.5 thread, thread length 18 mm	

**Ultrasonic sensor
diffuse mode sensor
QS18UPAEQ8**

Wiring accessories

Type code	Ident no.	Description	Dimension drawing
RKC4.4T-2/TEL	6625013	Connection cable, female M12, straight, 4-pin, cable length: 2 m, sheath material: PVC, black; cULus approval; other cable lengths and qualities available, see www.turck.com	
WKC4.4T-2/TEL	6625025	Connection cable, female M12, angled, 4-pin, cable length: 2 m, sheath material: PVC, black; cULus approval; other cable lengths and qualities available, see www.turck.com	

Function accessories

Type code	Ident no.	Description	Dimension drawing
UWG18-6.4	3076952	Ultrasonic focussing-adaptor for QS18U and S18U, internal diameter 6.4 mm	
UWG18-5.0	3077342	Ultrasonic focussing-adaptor for QS18U and S18U, internal diameter 5.0 mm	
VB2-SP2	6999083	Teach adapter for ultrasonic sensors, types RUN and RUR	