

**Photoelectric sensor
bifurcated retroreflective sensor
SLM120B6**

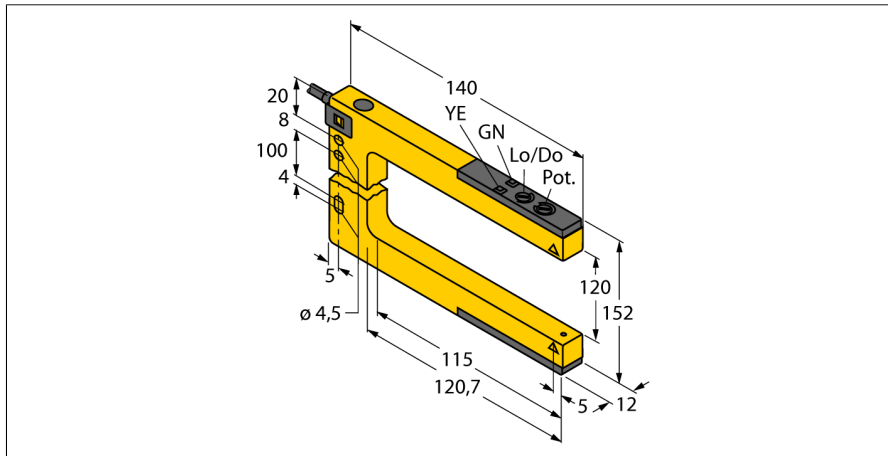

- Cable, PVC, 2 m
- Protection class IP67
- Sensitivity adjusted via potentiometer
- Operating voltage: 10...30 VDC
- Switching output, bipolar, light or dark operation

Wiring diagram

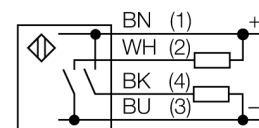

Functional principle

Bifurcated retro-reflective sensors and opposed mode sensors - The advantages of two sensor types combined in a single compact housing. Additional alignment of emitter and receiver is no longer required. The slot widths are 10 mm, 30 mm, 50 mm, 80 mm, 120 mm and 220 mm. The sensor features a potentiometer to adjust the sensitivity and a rotary switch to set light or dark switching.

Type code	SLM120B6
Ident no.	3074985
Operating mode	bifurcated retro-reflective sensor
Light type	red
Wavelength	680 nm
Ambient temperature	-20...+60 °C
Operating voltage	10...30VDC
Residual ripple	< 10 % U _s
DC rated operational current	≤ 100 mA
No-load current I ₀	≤ 25 mA
Short-circuit protection	yes
Reverse polarity protection	yes
Output function	NO contact, PNP/NPN
Switching frequency	≤ 1000 Hz
Design	slot sensor, SLM120
Dimensions	140 x 12 x 152 mm
Housing material	metal/plastic, ZN
Lens	plastic, acrylic
Connection	cable, PVC
Cable length	2 m
Cable cross section	4 x 0.35 mm ²
Protection class	IP67
Power-on indication	LED green
Switching state	LED yellow
Error indication	LED
Alarm display	LED yellow flashing