

**Photoelectric sensor  
convergent mode laser sensor  
PD45VP6C200Q**

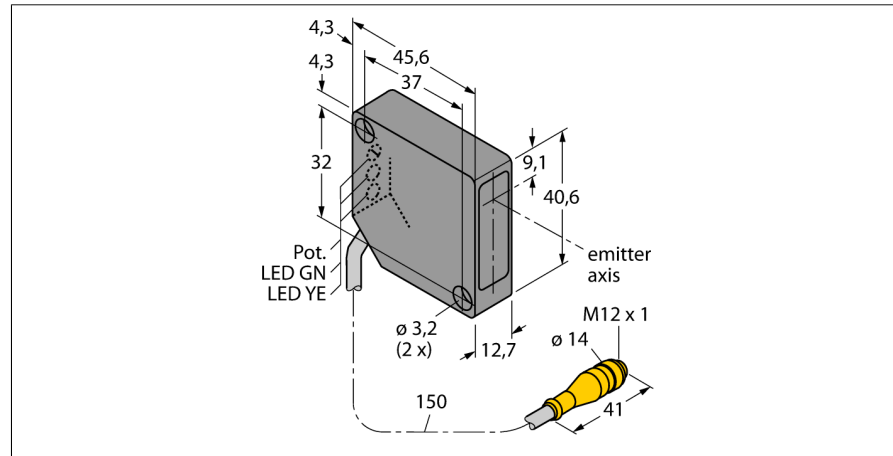

- High excess gain
- Focal point, Ø 0.25 mm
- M12 x 1 male connector
- Sensitivity adjustable via potentiometer
- Light and dark operation

**Wiring diagram**

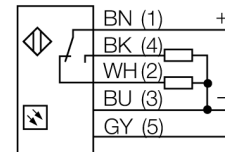

<b>Type code</b>	PD45VP6C200Q
Ident no.	3048324
<b>Operating mode</b>	Convergent mode laser sensor (triangulation)
Light type	red
Wavelength	670 nm
Focal distance	203 mm
Laser class	△ 2
Beam diameter	0,25 mm
Ambient temperature	-10...+45 °C
<b>Operating voltage</b>	10...30VDC
No-load current I <sub>0</sub>	≤ 20 mA
Output function	changover contact, PNP
Switching frequency	2.5 kHz
Readiness delay	≤ 1 s
Overcurrent release	> 220 mA
<b>Design</b>	rectangular, PicoDot
Dimensions	45.6 x 12.7 x 40.6 mm
Housing material	plastic, ABS
Lens	plastic, acrylic
Connection	cable with connector, M12 x 1
Protection class	IP54
<b>Power-on indication</b>	LED green
Switching state	LED yellow
Error indication	LED green flashing

**Functional principle**

Convergent mode sensors are equipped with a lens in front of the emitter diode that produces a small and intense focal point at a defined distance from the sensor. Similar to diffuse mode sensors, the light reflected by the target is evaluated. Convergent mode sensors are particularly suited for detection of small targets or edges. Based on the intense light concentration in the focal point, convergent mode sensors are capable of detecting targets with a low reflectivity.

**Excess gain curve**

Excess gain in relation to the distance

