

**Photoelectric sensor  
convergent mode sensor  
Q45AD9CV4Q**

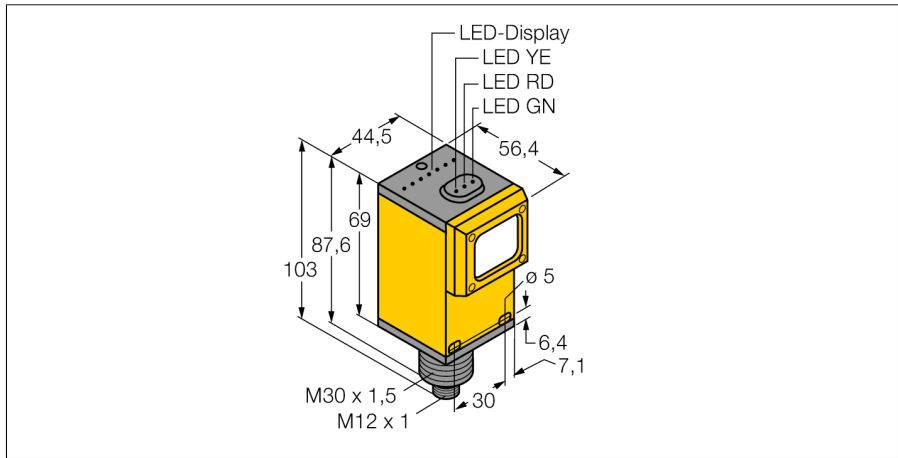

- ATEX category II 1 G, Ex zone 0
- Male M12 x 1
- Protection class IP67
- Sensitivity adjusted via potentiometer
- Operating voltage: 5...15 VDC
- NAMUR output: dark  $\leq$  1.2 mA ; light  $\geq$  2.1 mA
- Acc. to EN 60947-5-6 (NAMUR)

**Wiring diagram**

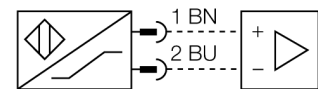

<b>Type code</b>	Q45AD9CV4Q
Ident no.	3037634
<b>Operating mode</b>	convergent mode sensor
Light type	red
Wavelength	680 nm
Focal distance	100 mm
Ambient temperature	-40...+70 °C
<b>Voltage</b>	Nom. 8.2 VDC
Non-actuated current consumption	$\leq$ 1 mA
Actuated current consumption	$\geq$ 2.1 mA
No-load current $I_0$	$\leq$ 2.1 mA
Output function	light operation, NAMUR
Switching frequency	$\leq$ 100 Hz
<b>Device designation</b>	Ex II 1 G Ex ia IIC T5
<b>Design</b>	rectangular, Q45
Dimensions	56.4 x 44.5 x 102.6 mm
Housing material	plastic, PBT
Lens	plastic, acrylic
Connection	male, M12 x 1
Protection class	IP67
MTTF	67 years acc. to SN 29500 (Ed. 99) 40 °C
Protection type	Ex ia IIC T6
Ex approval acc. to conformity certificate	KEMA 03ATEX 1441 X
<b>Switching state</b>	LED red

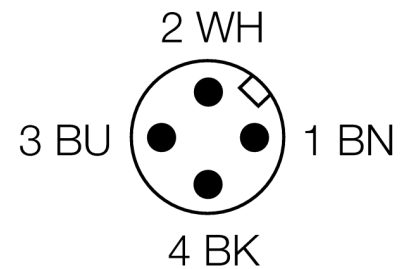

**Functional principle**

Convergent mode sensors are equipped with a lens in front of the emitter diode that produces a small and intense focal point at a defined distance from the sensor. Similar to diffuse mode sensors, the light reflected by the target is evaluated. Convergent mode sensors are ideal for detection of small targets or colour marks and edge guiding or positioning control of transparent materials. The targets must always be within the focal depth of the sensors. The focal depth is defined as the area in front of or behind the focal point within which the object can be detected. Based on the intense light concentration in the focal point, convergent mode sensors are capable of detecting targets with a low reflectivity.

**Excess gain curve**

Excess gain in relation to the distance

Photoelectric sensor  
convergent mode sensor  
Q45AD9CV4Q

**TURCK**

Industrial  
Automation

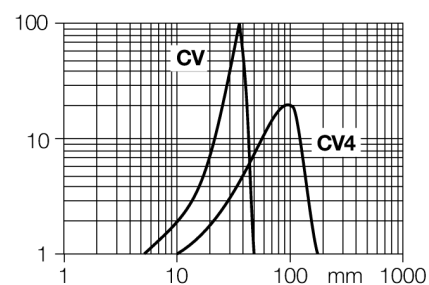

Photoelectric sensor  
convergent mode sensor  
Q45AD9CV4Q

**TURCK**

Industrial  
Automation

Accessories

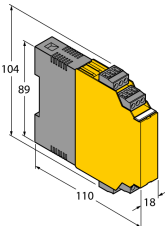
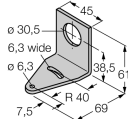
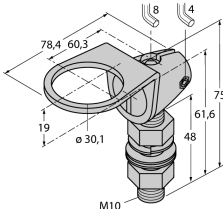
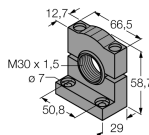
Type code	Ident no.	Description	Dimension drawing
IM1-22EX-R/24VDC	7541210	isolating switching amplifier, two channels; input for NAMUR signals; optional wire-break and short-circuit monitoring function; selectable normally open or normally closed performance; removable terminal blocks; 18 mm wide; supply voltage 24 VDC	
SMB30A	3032723	Mounting bracket, stainless steel, for sensors with 30 mm thread	
SMB30FAM10	3011185	Mounting bracket, stainless steel, for M10 x 1.5 thread, thread length 30 mm	
SMB30SC	3052521	Mounting bracket, PBT black; for 30 mm thread; with 4 screws M5 x 0.8	

# Photoelectric sensor convergent mode sensor Q45AD9CV4Q

**TURCK**

Industrial  
Automation

## Operating manual

### Intended use

This device fulfills the directive 94/9/EC and is suited for use in explosion hazardous areas according to EN60079-0:2009, -11:2012, -26:2007. In order to ensure correct operation to the intended purpose it is required to observe the national regulations and directives.

### For use in explosion hazardous areas conform to classification

II 1 G (Group II, Category 1 G, electrical equipment for gaseous atmospheres).

### Marking (see device or technical data sheet)

Ex II 1 G and Ex ia IIC T5 acc. to EN60079-0, -11 and -26

### Local admissible ambient temperature

-25...+70 °C

### Installation / Commissioning

These devices may only be installed, connected and operated by trained and qualified staff. Qualified staff must have knowledge of protection classes, directives and regulations concerning electrical equipment designed for use in explosion hazardous areas. Please verify that the classification and the marking on the device comply with the actual application conditions.

This device is only suited for connection to approved Exi circuits compliant to EN60079-0 and -11. Please observe the maximum admissible electrical values.

After connection to other circuits the sensor may no longer be used in Exi installations. When interconnected to (associated) electrical equipment, it is required to perform the "Proof of intrinsic safety" (EN60079-14).

### Installation and mounting instructions

Avoid static charging of cables and plastic devices. Please only clean the device with a damp cloth. Do not install the device in a dust flow and avoid build-up of dust deposits on the device.

If the devices and the cable could be subject to mechanical damage, they must be protected accordingly. They must also be shielded against strong electro-magnetic fields.

The pin configuration and the electrical specifications can be taken from the device marking or the technical data sheet.

In order to avoid contamination of the device, please remove possible blanking plugs of the cable glands or connectors only shortly before inserting the cable or opening the cable socket.

### service / maintenance

Repairs are not possible. The approval expires if the device is repaired or modified by a person other than the manufacturer. The most important data from the approval are listed.