

Photoelectric sensor
laser sensor, diffuse mode, with adjustable background suppression
Q60BB6LAF2000

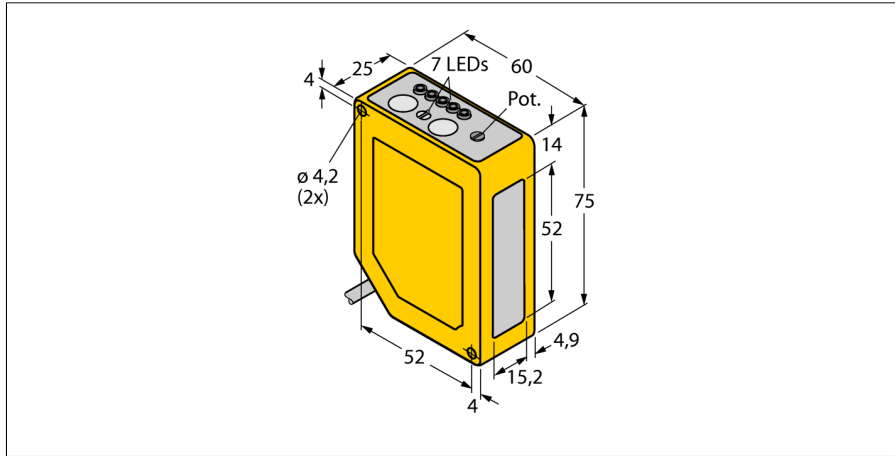

- Cable, PVC, 2 m
- Protection class IP67
- 5-segement LED display
- Signal indication
- Keylock
- Switch ON/OFF delay, adjustable between 8...16 ms
- Operating voltage: 10...30 VDC
- Switching output, bipolar
- Light or dark operation

Wiring diagram

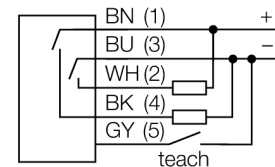

Functional principle

Diffuse mode sensors with background suppression operate with a single emitter and several receiver elements. The target position and the photoelectric structure of the sensor determine which of the receiving elements receives the most light. The sensor electronics determine whether the reflecting object is within or outside the measuring range. The sensors come with an adjustable or fixed cut-off point.

Deviation curve

Deviation of the cut-off point of a 18 % grey or 6 % black target relative to the cut-off point of a white target

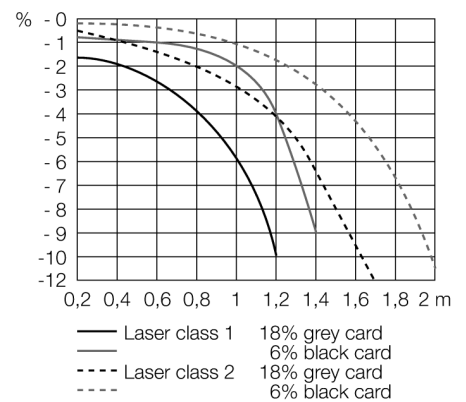

Type code	Q60BB6LAF2000
Ident no.	3071634
Operating mode	Diffuse mode laser sensor (time-of-fly) with adjustable background suppression
Light type	red
Wavelength	650 nm
Laser class	▲ 2
Range	200...2000 mm
Ambient temperature	-10...+50 °C
Operating voltage	10...30VDC
Residual ripple	< 10 % U _s
No-load current I ₀	≤ 50 mA
Reverse polarity protection	yes
Output function	NO contact, PNP/NPN
Switching frequency	≤ 250 Hz
Readiness delay	≤ 1000 ms
Design	rectangular, Q60
Dimensions	60 x 25 x 75 mm
Housing material	plastic, ABS, yellow
Lens	plastic, acrylic
Connection	cable, PVC
Cable length	2 m
Cable cross section	5 x 0.5 mm ²
Protection class	IP67
MTTF	19 years acc. to SN 29500 (Ed. 99) 40 °C
Power-on indication	LED green
Switching state	LED yellow
Error indication	LED
Excess gain indication	LED green flashing

**Photoelectric sensor
laser sensor, diffuse mode, with adjustable background suppression
Q60BB6LAF2000**

Accessories

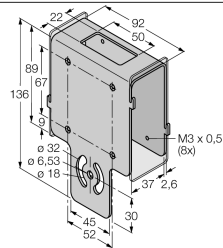
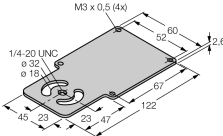
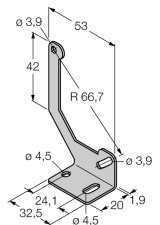
Type code	Ident no.	Description	Dimension drawing
SMBAMSQ60IP	3073441	Protective housing with safety glas panel, stainless steel, for Q60	 <p>Technical drawing of the protective housing showing dimensions: 22, 92, 50, 89, 67, 136, 32, 6,53, 18, 45, 52, 37, 2,6, 30, and M3 x 0,5 (8x).</p>
SMBAMSQ60P	3073133	Backplane, stainless steel, for Q60 series	 <p>Technical drawing of the backplane showing dimensions: M3 x 0,5 (4x), 1/4-20 UNC, 32, 19, 45, 23, 23, 47, 122, 67, 52, 60, 2,6.</p>
SMBQ60	3067592	Mounting bracket, stainless steel, for Q60 series	 <p>Technical drawing of the mounting bracket showing dimensions: 3,9, 63, 42, R 66,7, 4,5, 24,1, 32,5, 20, 1,9, 3,9, 4,5.</p>