

**Photoelectric sensor
diffuse mode sensor
MIAD9WQ**

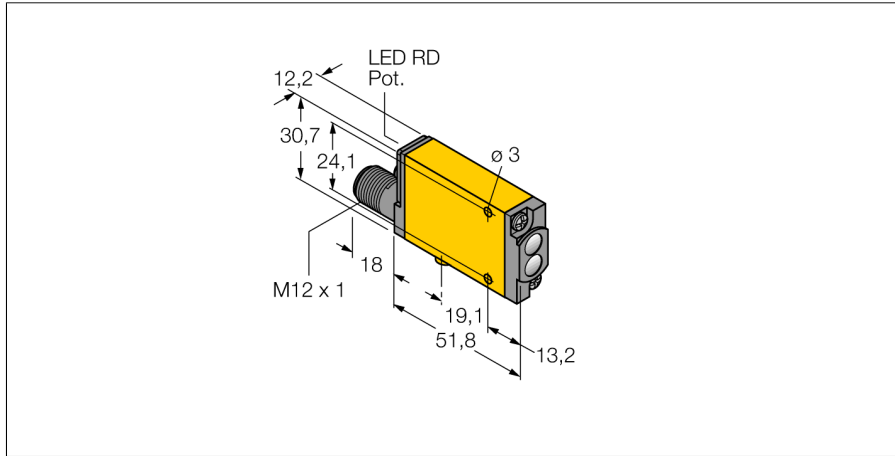

- ATEX II 1 G approval
- Acc. to EN 60947-5-6 (NAMUR)
- Metallic optical fibers must be grounded
- Male M12 x 1, 4-pin
- Protection class IP67
- Sensitivity adjustable via potentiometer
- Alignment indicator
- Operating voltage: 5...15 VDC (NAMUR)
- Switching output, bipolar
- Light/dark operation

Wiring diagram

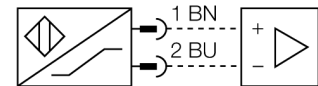

Type code	MIAD9WQ
Ident no.	3035233
Operating mode	diffuse mode sensor
Light type	IR
Wavelength	880 nm
Range	0...75 mm
Ambient temperature	-40...+70 °C
Voltage	Nom. 8.2 VDC
Non-actuated current consumption	≤ 1.2 mA
Actuated current consumption	≥ 2.1 mA
Output function	light operation, NAMUR
Switching frequency	≤ 100 Hz
Device designation	Ex II 1 G Ex ia IIC T5
Design	rectangular, Mini Beam
Dimensions	69.8 x 12.3 x 30.7 mm
Housing material	plastic, PBT, yellow
Lens	plastic, acrylic
Connection	male, M12 x 1
Protection class	IP67
Protection type	Ex ia IIC T5 Ga
Ex approval acc. to conformity certificate	FM12ATEX0094X
Switching state	LED red
Excess gain indication	LED red flashing

Functional principle

Diffuse mode sensors incorporate the emitter and receiver in a single housing. However, diffuse mode sensors do not detect the interruption of the light beam like opposed mode sensors, but the reflection of the target. A target is detected if it reflects a sufficient amount of light back to the receiver. The switching distance of diffuse mode sensors thus largely depends on the reflectivity of the target.

Excess gain curve

Excess gain in relation to the distance

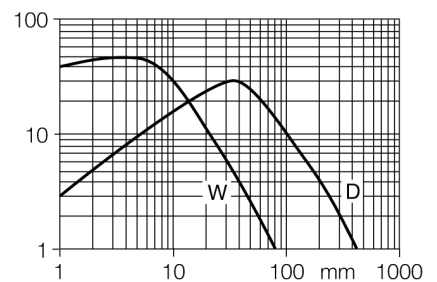

Photoelectric sensor
diffuse mode sensor
MIAD9WQ

TURCK

Industrial
Automation

Accessories

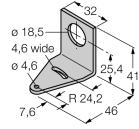
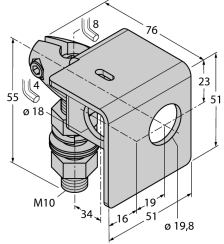
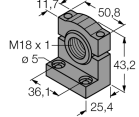
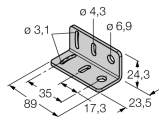
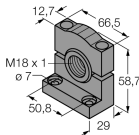
Type code	Ident no.	Description	Dimension drawing
SMB18A	3033200	Mounting bracket, stainless steel, for sensors with 18 mm thread	
SMB18AFAM10	3012558	Mounting bracket, material VA 1.4401, for M10 x 1.5 thread, thread length 18 mm	
SMB18SF	3052519	Mounting bracket, PTB black steel, for sensors with 18 mm thread	
SMB312B	3025519	Mounting bracket, stainless steel, for MINI-BEAM NAMUR	
SMB3018SC	3053952	Mounting bracket, PTB black, for sensors with 18 mm thread	

Wiring accessories

Type code	Ident no.	Description	Dimension drawing
MQD9-406	3045135	Connection cable, female M12, 4-pin, cable length: 1.83 m, sheath material: PVC, blue; other cable lengths and qualities available, see www.turck.com	

**Photoelectric sensor
diffuse mode sensor
MIAD9WQ**

TURCK

Industrial
Automation

Wiring accessories

Type code	Ident no.	Description	Dimension drawing
MQD9-406RA	3047106	Connection cable, female M12, angled, 4-pin, cable length: 1.83 m, sheath material: PVC, blue; other cable lengths and qualities available, see www.turck.com	

Function accessories

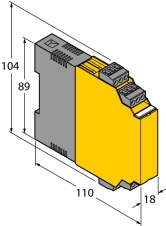
Type code	Ident no.	Description	Dimension drawing
IM1-22EX-R	7541231	Isolating switching amplifier, dual-channel; 2 relay outputs NO; input NAMUR signal; selectable ON/OFF mode for wire-break and short-circuit monitoring; adjustable signal flow (NO/ NC mode); removable terminal blocks; 18 mm width; universal voltage supply unit	

Photoelectric sensor diffuse mode sensor MIAD9WQ

TURCK

Industrial
Automation

Operating manual

Intended use

This device fulfills the directive 94/9/EC and is suited for use in explosion hazardous areas according to EN60079-0:2009, -11:2012, -26:2007. In order to ensure correct operation to the intended purpose it is required to observe the national regulations and directives.

For use in explosion hazardous areas conform to classification

II 1 G (Group II, Category 1 G, electrical equipment for gaseous atmospheres).

Marking (see device or technical data sheet)

Ex II 1 G and Ex ia IIC T5 acc. to EN60079-0, -11 and -26

Local admissible ambient temperature

-25...+70 °C

Installation / Commissioning

These devices may only be installed, connected and operated by trained and qualified staff. Qualified staff must have knowledge of protection classes, directives and regulations concerning electrical equipment designed for use in explosion hazardous areas. Please verify that the classification and the marking on the device comply with the actual application conditions.

This device is only suited for connection to approved Exi circuits compliant to EN60079-0 and -11. Please observe the maximum admissible electrical values.

After connection to other circuits the sensor may no longer be used in Exi installations. When interconnected to (associated) electrical equipment, it is required to perform the "Proof of intrinsic safety" (EN60079-14).

Installation and mounting instructions

Avoid static charging of cables and plastic devices. Please only clean the device with a damp cloth. Do not install the device in a dust flow and avoid build-up of dust deposits on the device.

If the devices and the cable could be subject to mechanical damage, they must be protected accordingly. They must also be shielded against strong electro-magnetic fields.

The pin configuration and the electrical specifications can be taken from the device marking or the technical data sheet.

In order to avoid contamination of the device, please remove possible blanking plugs of the cable glands or connectors only shortly before inserting the cable or opening the cable socket.

service / maintenance

Repairs are not possible. The approval expires if the device is repaired or modified by a person other than the manufacturer. The most important data from the approval are listed.