

**Photoelectric sensor
diffuse mode sensor
Q45AD9DLQ**

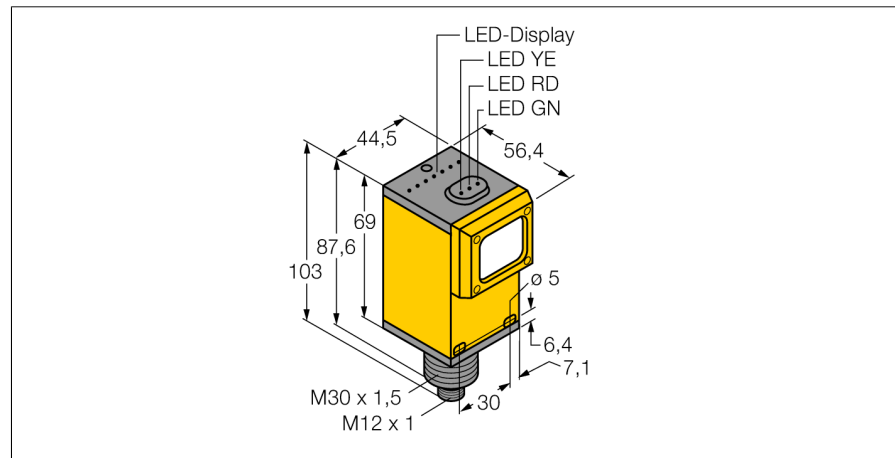

- ATEX category II 1 G, Ex zone 0
- Male M12 x 1
- Protection class IP67
- Sensitivity adjusted via potentiometer
- Operating voltage: 5...15 VDC
- NAMUR output: dark ≤ 1.2 mA ; light ≥ 2.1 mA
- Acc. to EN 60947-5-6 (NAMUR)

Wiring diagram

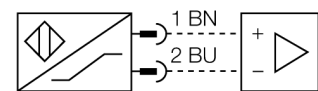

| | |
|--|--|
| Type code | Q45AD9DLQ |
| Ident no. | 3037628 |
| Operating mode | diffuse mode sensor |
| Light type | IR |
| Wavelength | 880 nm |
| Range | 0...1070 mm |
| Ambient temperature | -40...+70 °C |
| Voltage | Nom. 8.2 VDC |
| Non-actuated current consumption | ≤ 1 mA |
| Actuated current consumption | ≥ 2.1 mA |
| No-load current I_0 | ≤ 2.1 mA |
| Output function | light operation, NAMUR |
| Switching frequency | ≤ 100 Hz |
| Device designation | Ex II 1 G Ex ia IIC T5 |
| Design | rectangular, Q45 |
| Dimensions | 103 x 54.1 x 44.5 mm |
| Housing material | plastic, PBT |
| Lens | plastic, acrylic |
| Connection | male, M12 x 1 |
| Protection class | IP67 |
| MTTF | 67 years acc. to SN 29500 (Ed. 99) 40 °C |
| Protection type | Ex ia IIC T6 |
| Ex approval acc. to conformity certificate | KEMA 03ATEX 1441 X |
| Switching state | LED red |

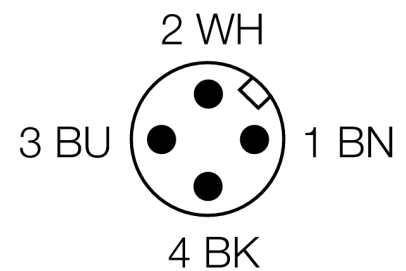

Functional principle

Like retroreflective sensors, diffuse mode sensors also contain emitter and receiver circuitry in the same housing. However, diffuse mode sensors do not detect the interruption of the light beam but the reflection of the object. An object is detected if it reflects sufficient light back to the receiver. The switching distance of diffuse mode sensors thus largely depends on the object's reflectivity. This type of sensor is especially suited for detection of transparent objects (diffuse mode sensor with or without background suppression or convergent mode sensors).

Excess gain curve

Excess gain in relation to distance

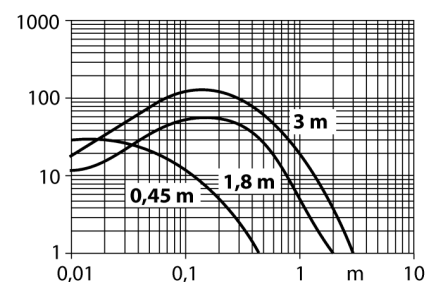

Photoelectric sensor
diffuse mode sensor
Q45AD9DLQ

TURCK

Industrial
Automation

Accessories

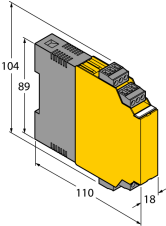
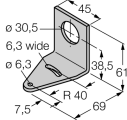
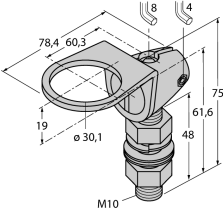
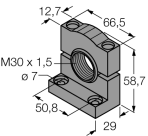
| Type code | Ident no. | Description | Dimension drawing |
|------------------|-----------|--|---|
| IM1-22EX-R/24VDC | 7541210 | isolating switching amplifier, two channels; input for NAMUR signals; optional wire-break and short-circuit monitoring function; selectable normally open or normally closed performance; removable terminal blocks; 18 mm wide; supply voltage 24 VDC |  |
| SMB30A | 3032723 | Mounting bracket, stainless steel, for sensors with 30 mm thread |  |
| SMB30FAM10 | 3011185 | Mounting bracket, stainless steel, for M10 x 1.5 thread, thread length 30 mm |  |
| SMB30SC | 3052521 | Mounting bracket, PBT black; for 30 mm thread; with 4 screws M5 x 0.8 |  |

Photoelectric sensor diffuse mode sensor Q45AD9DLQ

TURCK

Industrial
Automation

Operating manual

Intended use

This device fulfills the directive 94/9/EC and is suited for use in explosion hazardous areas according to EN60079-0:2009, -11:2012, -26:2007. In order to ensure correct operation to the intended purpose it is required to observe the national regulations and directives.

For use in explosion hazardous areas conform to classification

II 1 G (Group II, Category 1 G, electrical equipment for gaseous atmospheres).

Marking (see device or technical data sheet)

Ex II 1 G and Ex ia IIC T5 acc. to EN60079-0, -11 and -26

Local admissible ambient temperature

-25...+70 °C

Installation / Commissioning

These devices may only be installed, connected and operated by trained and qualified staff. Qualified staff must have knowledge of protection classes, directives and regulations concerning electrical equipment designed for use in explosion hazardous areas.

Please verify that the classification and the marking on the device comply with the actual application conditions.

This device is only suited for connection to approved Exi circuits compliant to EN60079-0 and -11. Please observe the maximum admissible electrical values.

After connection to other circuits the sensor may no longer be used in Exi installations. When interconnected to (associated) electrical equipment, it is required to perform the "Proof of intrinsic safety" (EN60079-14).

Installation and mounting instructions

Avoid static charging of cables and plastic devices. Please only clean the device with a damp cloth. Do not install the device in a dust flow and avoid build-up of dust deposits on the device.

If the devices and the cable could be subject to mechanical damage, they must be protected accordingly. They must also be shielded against strong electro-magnetic fields.

The pin configuration and the electrical specifications can be taken from the device marking or the technical data sheet.

In order to avoid contamination of the device, please remove possible blanking plugs of the cable glands or connectors only shortly before inserting the cable or opening the cable socket.

service / maintenance

Repairs are not possible. The approval expires if the device is repaired or modified by a person other than the manufacturer. The most important data from the approval are listed.