

**Photoelectric sensor
diffuse mode sensor
Q45BB6DLQ5**

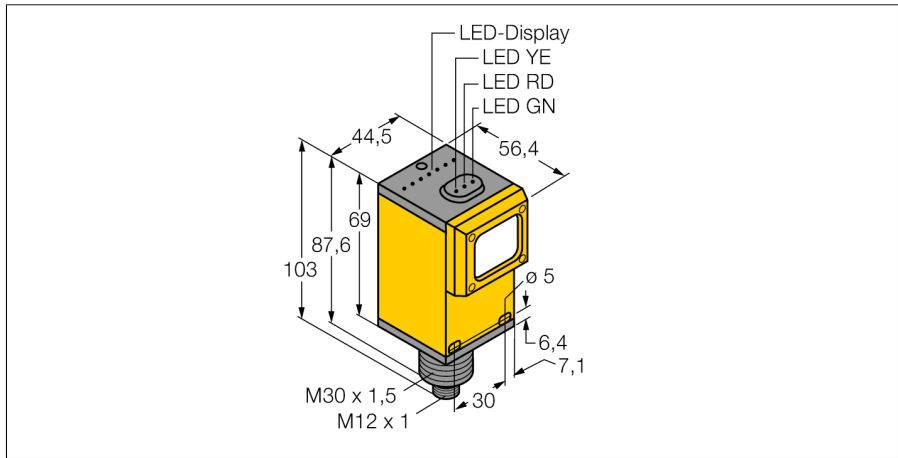

- Male M12 x 1
- Protection class IP67
- Sensitivity adjusted via potentiometer
- Operating voltage: 10...30 VDC
- Switching output, bipolar
- Light or dark operation, adjusted via switch

Wiring diagram

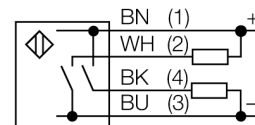

Type code	Q45BB6DLQ5
Ident no.	3038664
Operating mode	diffuse mode sensor
Light type	IR
Wavelength	880 nm
Range	0...1800 mm
Ambient temperature	-40...+70 °C
Operating voltage	10...30VDC
Residual ripple	< 10 % U _s
DC rated operational current	≤ 150 mA
No-load current I ₀	≤ 50 mA
Short-circuit protection	yes/ cyclic
Reverse polarity protection	yes
Output function	NO contact, PNP/NPN
Switching frequency	≤ 250 Hz
Readiness delay	≤ 100 ms
Overcurrent release	> 220 mA
Design	rectangular, Q45
Dimensions	103 x 56.4 x 44.5 mm
Housing material	plastic, PBT
Lens	acrylic, acrylic
Connection	male, M12 x 1
Protection class	IP67
MTTF	67 years acc. to SN 29500 (Ed. 99) 40 °C
Power-on indication	LED green
Switching state	LED yellow
Error indication	LED green flashing
Excess gain indication	LED red

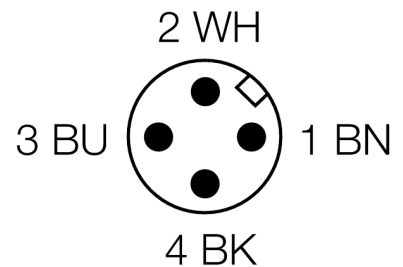

Functional principle

Like retroreflective sensors, diffuse mode sensors also contain emitter and receiver circuitry in the same housing. However, diffuse mode sensors do not detect the interruption of the light beam but the reflection of the object. An object is detected if it reflects sufficient light back to the receiver. The switching distance of diffuse mode sensors thus largely depends on the object's reflectivity. This type of sensor is especially suited for detection of transparent objects (diffuse mode sensor with or without background suppression or convergent mode sensors).

Excess gain curve

Excess gain in relation to distance

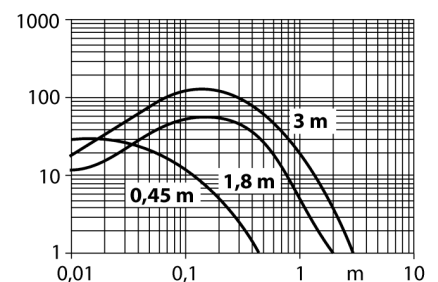

**Photoelectric sensor
diffuse mode sensor
Q45BB6DLQ5**

Accessories

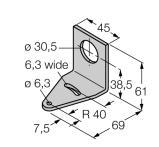
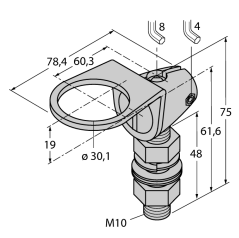
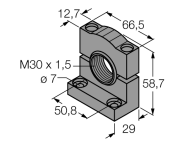
Type code	Ident no.	Description	Dimension drawing
SMB30A	3032723	Mounting bracket, stainless steel, for sensors with 30 mm thread	
SMB30FAM10	3011185	Mounting bracket, stainless steel, for M10 x 1.5 thread, thread length 30 mm	
SMB30SC	3052521	Mounting bracket, PBT black; for 30 mm thread; with 4 screws M5 x 0.8	

Wiring accessories

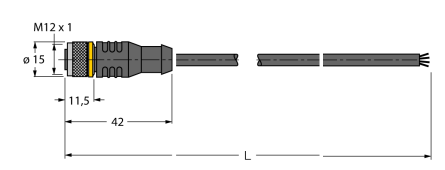
Type code	Ident no.	Description	Dimension drawing
RKC4.4T-2/TEL	6625013	Connection cable, female M12, straight, 4-pin, cable length: 2 m, sheath material: PVC, black; cULus approval; other cable lengths and qualities available, see www.turck.com	
WKC4.4T-2/TEL	6625025	Connection cable, female M12, angled, 4-pin, cable length: 2 m, sheath material: PVC, black; cULus approval; other cable lengths and qualities available, see www.turck.com	