

**Photoelectric sensor
diffuse mode sensor
miniature sensor
T8RP6D50Q**

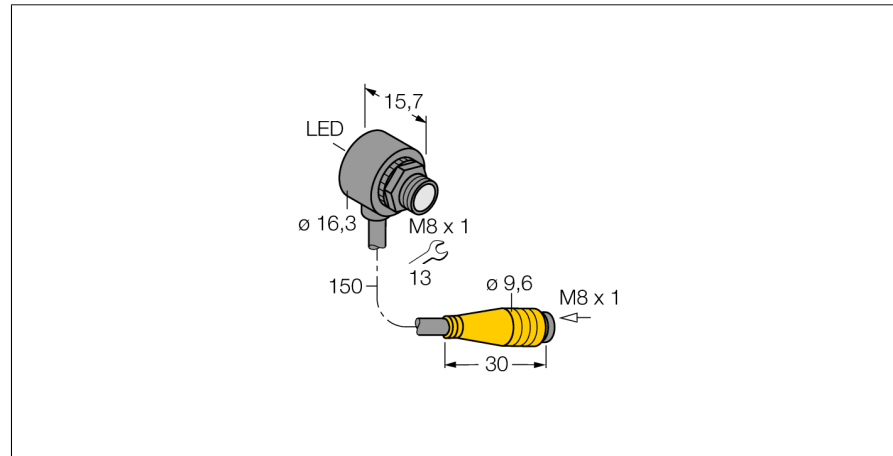

- Cable with male end, PVC, M8 x 1, 150 mm
- Protection class IP67
- Ambient temperature: -20...+55 °C
- Ideal for confined spaces
- Operating voltage: 10...30 VDC
- PNP switching output, dark operation

Wiring diagram

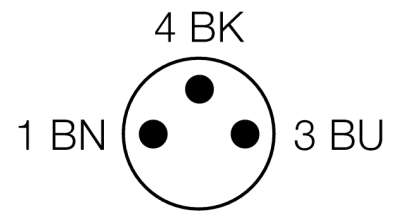
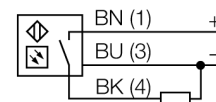

Type code	T8RP6D50Q
Ident no.	3066662
Operating mode	diffuse mode sensor
Light type	red
Wavelength	680 nm
Range	0...50 mm
Ambient temperature	-20...+55 °C
Operating voltage	10...30VDC
Residual ripple	< 10 % U _s
DC rated operational current	≤ 50 mA
No-load current I ₀	≤ 25 mA
Short-circuit protection	yes
Reverse polarity protection	yes
Output function	NO, dark operation, PNP
Switching frequency	≤ 500 Hz
Readiness delay	≤ 150 ms
Design	threaded barrel, T8
Dimensions	15.8 mm
Housing diameter	16.3 mm
Housing material	plastic, ABS, black
Lens	plastic, acrylic
Connection	cable with connector, M8 x 1
Cable cross section	3 x 0.1 mm ²
Protection class	IP67
Power-on indication	LED green
Switching state	LED red
Error indication	LED green flashing
Alarm display	LED red flashing

Functional principle

Identical to retro-reflective sensors, emitter and receiver circuitry are incorporated in the same housing of the diffuse mode sensors. However, diffuse mode sensors do not detect the interruption of the light beam but the reflection of the target. A target is detected if it reflects a sufficient amount of light back to the receiver. The switching distance of diffuse mode sensors thus largely depends on the reflectivity of the target. This type of sensor is especially suited for detection of transparent objects (diffuse mode sensor with or without background suppression or convergent mode sensors).

Excess gain curve

Excess gain in relation to the distance

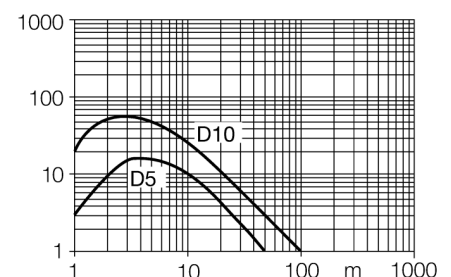

**Photoelectric sensor
diffuse mode sensor
miniature sensor
T8RP6D50Q**

Accessories

Type code	Ident no.	Description	Dimension drawing
SMB8MM	3067363	Mounting bracket, material VA 1.4401, for T8 or T8L series	

Wiring accessories

Type code	Ident no.	Description	Dimension drawing
PKG3M-2/TEL	6625058	Connection cable, female M8, straight, 3-pin, cable length: 2 m, sheath material: PVC, black; cULus approval; other cable lengths and qualities available, see www.turck.com	
PKW3M-2/TEL	6625064	Connection cable, female M8, angled, 3-pin, cable length: 2 m, sheath material: PVC, black; cULus approval; other cable lengths and qualities available, see www.turck.com	