

**Photoelectric sensor
diffuse mode sensor
QS30EDVQ**

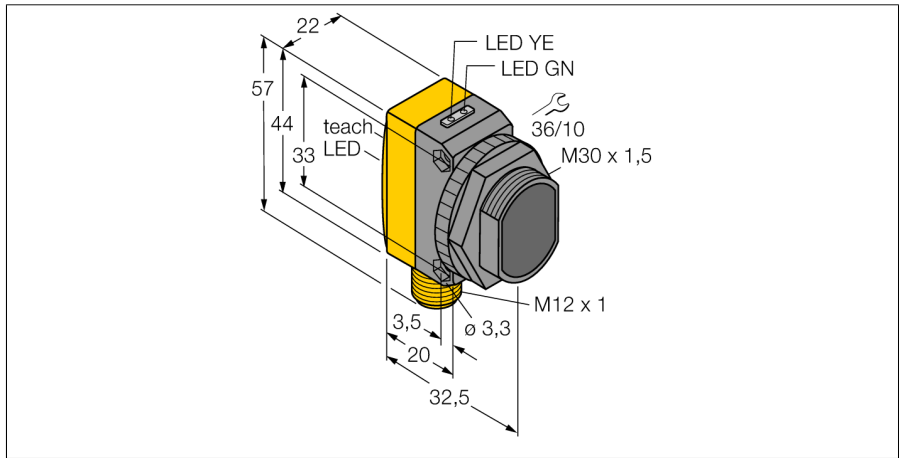

- Male M12 x 1, 5-pin
- Protection class IP67
- LED all-round visible
- Teach button
- 8-segment bargraph
- Operating voltage: 10...30 VDC
- Switching output, bipolar
- Light or dark operation

Wiring diagram

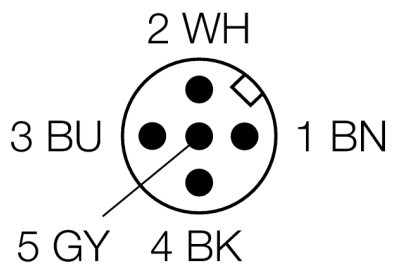
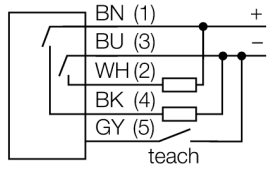

Type code	QS30EDVQ
Ident no.	3076092
Operating mode	diffuse mode sensor
Light type	red
Wavelength	660 nm
Range	2...1400 mm
Ambient temperature	-10...+55 °C
Operating voltage	10...30VDC
Residual ripple	< 10 % U _s
DC rated operational current	≤ 150 mA
No-load current I ₀	≤ 25 mA
Short-circuit protection	yes
Reverse polarity protection	yes
Output function	NO contact, PNP/NPN
Switching frequency	≤ 270 Hz
Readiness delay	≤ 100 ms
Design	rectangular, QS30
Dimensions	35 x 22 x 57 mm
Housing material	plastic, ABS, yellow
Lens	plastic, acrylic
Connection	male, M12 x 1
Protection class	IP67
MTTF	402 years acc. to SN 29500 (Ed. 99) 40 °C
Power-on indication	LED green
Switching state	LED yellow
Error indication	LED green flashing
Excess gain indication	LED red flashing

Functional principle

Identical to retro-reflective sensors, emitter and receiver circuitry are incorporated in the same housing of the diffuse mode sensors. However, diffuse mode sensors do not detect the interruption of the light beam but the reflection of the target. A target is detected if it reflects sufficient light back to the receiver. The switching distance of diffuse mode sensors thus largely depends on the reflectivity of the target.

Excess gain curve

Excess gain in relation to the distance

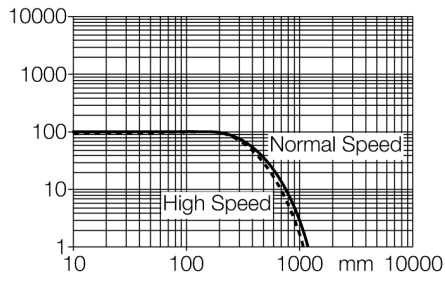

**Photoelectric sensor
diffuse mode sensor
QS30EDVQ**

TURCK

Industrial
Automation

Accessories

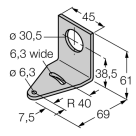
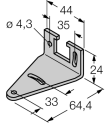
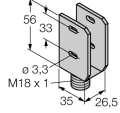
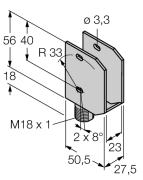
Type code	Ident no.	Description	Dimension drawing
SMB30A	3032723	Mounting bracket, stainless steel, for sensors with 30 mm thread	
SMBQS30L	3002809	Mounting bracket, stainless steel, for QS30 series	
SMBQS30Y	3002811	Protective housing, stainless steel, for QS30 series	
SMBQS30YL	3072741	Protective housing with safety glass panel, stainless steel, for QS30 series	

Wiring accessories

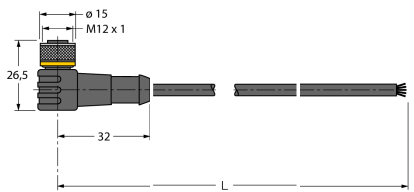
Type code	Ident no.	Description	Dimension drawing
WKC4.5T-2/TEL	6625028	Connection cable, female M12, angled, 5-pin, cable length: 2 m, sheath material: PVC, black; cULus approval; other cable lengths and qualities available, see www.turck.com	

**Photoelectric sensor
diffuse mode sensor
QS30EDVQ**

Wiring accessories

Type code	Ident no.	Description	Dimension drawing
RKC4.5T-2/TEL	6625016	Connection cable, female M12, straight, 5-pin, cable length: 2 m, sheath material: PVC, black; cULus approval; other cable lengths and qualities available, see www.turck.com	