

光电传感器
可调背景抑制型直反式传感器
QS18VP6AFF200Q

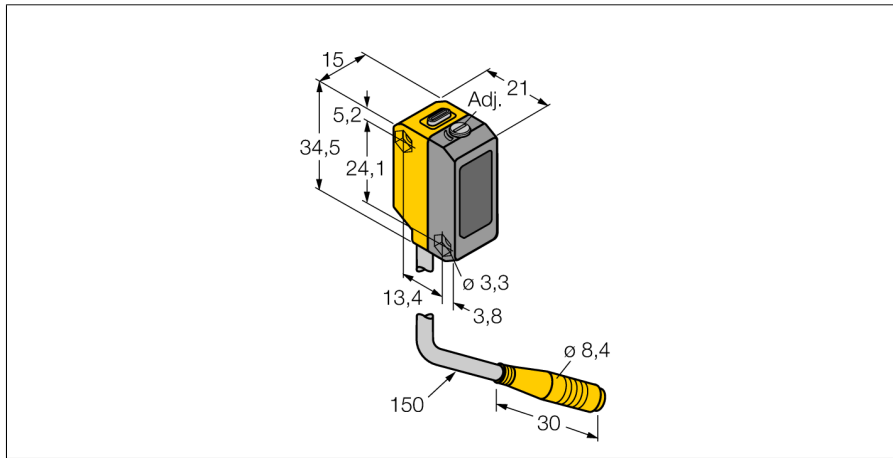

- M8 4针针座带150mmPVC线缆
- 防护等级IP67
- LED灯全角度可见
- 通过电位计调整关断点

接线图

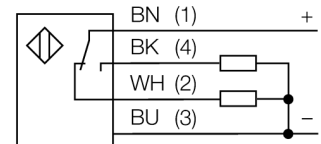

型号	QS18VP6AFF200Q
货号	3011473
工作模式	可调背景抑制型直反式传感器
发光模式	红
波长	660 nm
最大检测范围 [mm]	30...200 mm
环境温度	-20...+55 °C
工作电压	10...30VDC
漏波纹	< 10 % U _s
直流额定工作电流	≤ 100 mA
短路保护	是
反极性保护	是
输出性能	常开/常闭, PNP
开关频率	≤ 700 Hz
正常延迟	≤ 200 ms
设计	方型, QS18
尺寸	21.1x 15x 34.5 mm
外壳材料	塑料, ABS
镜头	塑料, 丙烯酸
连接	接插件线缆, PVC, Ø 8 mm
线缆长度	0.15 m
防护等级	IP67
MTTF	268 years 符合SN 29500 (Ed. 99) 40 °C认证
工作电压指示	LED指示灯 绿
开关状态指示	LED指示灯 黄
故障显示	LED指示灯 绿 齐平
过量增益指示	LED指示灯 黄 齐平

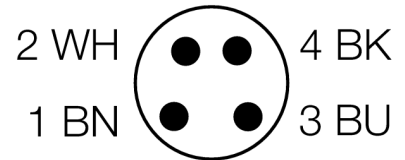

功能原理

Diffuse mode sensors with foreground and background suppression operate with a single emitter and two receiver elements, one for close range and one for far range. The target position and the photoelectric structure of the sensor determine which receiver element gets the most light. The optics in front of the receiver is modified with the adjusting screw until the boundary between close and far range is shifted. This operation determines whether the reflecting object is in or outside the measuring range.

Excess gain curves relating to the nearest and farthest cut-off point

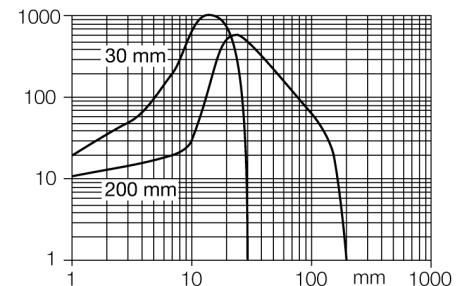

光电传感器
 可调背景抑制型直反式传感器
 QS18VP6AFF200Q

附件

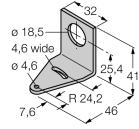
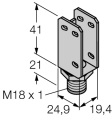
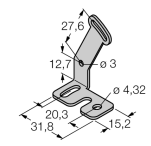
型号	货号	描述	尺寸图
SMB18A	3033200	不锈钢安装支架，适用18 mm圆柱传感器	
SMBQS18A	3069721	Mounting bracket, stainless steel, for 18 mm thread	
SMBQS18AF	3067467	Mounting bracket, stainless steel, for 18 mm thread	

Wiring accessories

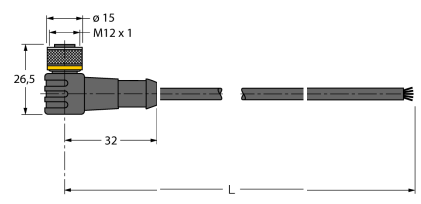
型号	货号	描述	尺寸图
WKC4.5T-2/TEL	6625028	连接线缆，孔头 M12、弯角；5 针，线缆长度：2 m；护套材质:PVC，黑色；cULus 认证；其他线路长度应可订货，详情参看 see www.turck.com	
RKC4.5T-2/TEL	6625016	线缆连接，孔头 M12、直角；5 针，线缆长度：2 m；护套材质:PVC，黑色；cULus 认证；其他线路长度应可订货，详情参看 see www.turck.com	