

Photoelectric sensor
diffuse mode sensor with fixed-field background suppression
S18SN6FF50Q

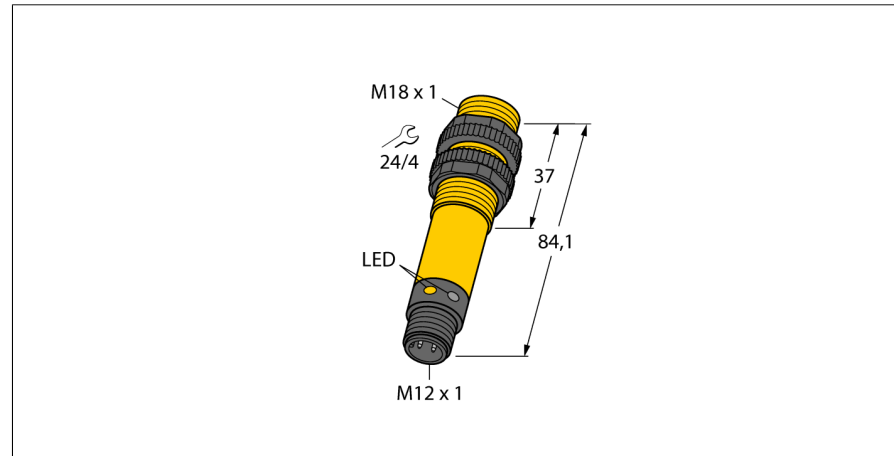

- Male M12 x 1, 5-pin
- Protection classes IP67/IP69K
- Ambient temperature: -40...+70 ° C
- Male M12 x 1

Wiring diagram

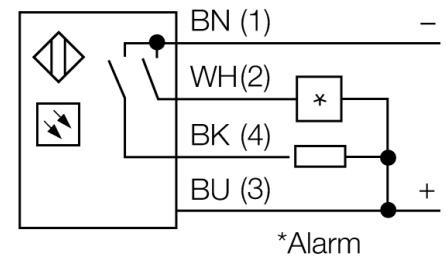
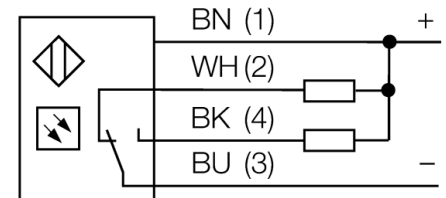

Functional principle

The emitter and receiver are incorporated in a single housing. The light reflection of the target is detected and triggers the sensor to switch. Thus the switching distance largely depends on the reflectivity of the target.

Excess gain curve

Excess gain in relation to the distance

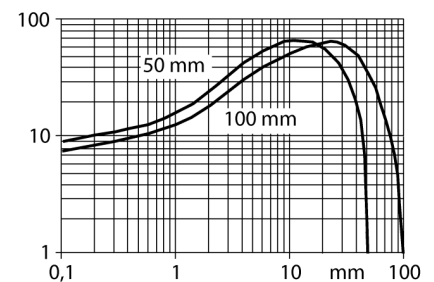

Type code	S18SN6FF50Q
Ident no.	3030867
Operating mode	diffuse mode sensor with fixed-field background suppression
Light type	IR
Wavelength	880 nm
Range	0...50 mm
Ambient temperature	-40...+70 °C
Operating voltage	10...30VDC
No-load current I ₀	≤ 35 mA
Short-circuit protection	yes/ cyclic
Reverse polarity protection	yes
Output function	connection programmable, NPN
Switching frequency	≤ 160 Hz
Readiness delay	≤ 100 ms
Overcurrent release	> 220 mA
Design	cylindrical/threaded, S18
Dimensions	84.1 mm
Housing diameter	18 mm
Housing material	plastic, PBT
Lens	plastic, acrylic
Connection	male, M12 x 1
Protection class	IP67 / IP69K
MTTF	448 years acc. to SN 29500 (Ed. 99) 40 °C
Power-on indication	LED green
Switching state	LED yellow
Error indication	LED green flashing
Alarm display	LED yellow flashing

**Photoelectric sensor
diffuse mode sensor with fixed-field background suppression
S18SN6FF50Q**

Accessories

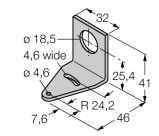
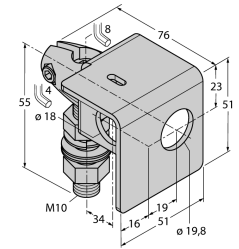
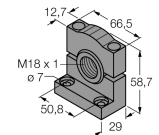
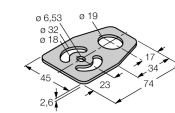
Type code	Ident no.	Description	Dimension drawing
SMB18A	3033200	Mounting bracket, stainless steel, for sensors with 18 mm thread	
SMB18AFAM10	3012558	Mounting bracket, material VA 1.4401, for M10 x 1.5 thread, thread length 18 mm	
SMB3018SC	3053952	Mounting bracket, PTB black, for sensors with 18 mm thread	
SMBAMS18P	3073134	Mounting bracket, stainless steel, for sensors with 18 mm thread	

Wiring accessories

Type code	Ident no.	Description	Dimension drawing
RKC4.4T-2/TEL	6625013	Connection cable, female M12, straight, 4-pin, cable length: 2 m, sheath material: PVC, black; cULus approval; other cable lengths and qualities available, see www.turck.com	

**Photoelectric sensor
diffuse mode sensor with fixed-field background suppression
S18SN6FF50Q**

Wiring accessories

Type code	Ident no.	Description	Dimension drawing
WKC4.4T-2/TEL	6625025	Connection cable, female M12, angled, 4-pin, cable length: 2 m, sheath material: PVC, black; cULus approval; other cable lengths and qualities available, see www.turck.com	