

**Photoelectric sensor**  
**diffuse mode sensor with fixed-field background suppression**  
**Q25SN6FF100Q**

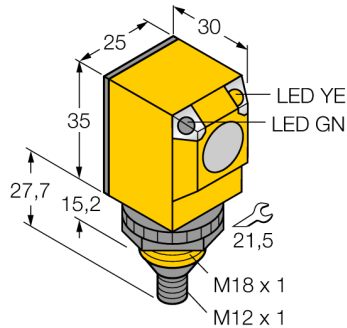

- Male M12 x 1, 5-pin
- Protection classes IP67/IP69K
- Ambient temperature: -40...+70 ° C
- Operating voltage: 10...30 VDC
- NPN switching output, changeover

**Wiring diagram**

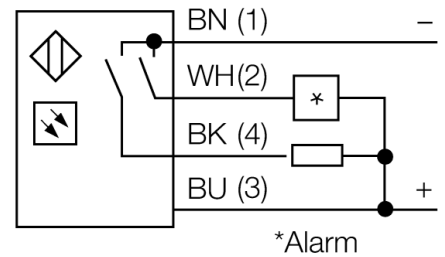

**Functional principle**

The emitter and receiver are incorporated in a single housing. The light reflection of the target is detected and triggers the sensor to switch. Thus the switching distance largely depends on the reflectivity of the target.

**Excess gain curve**

Excess gain in relation to the distance

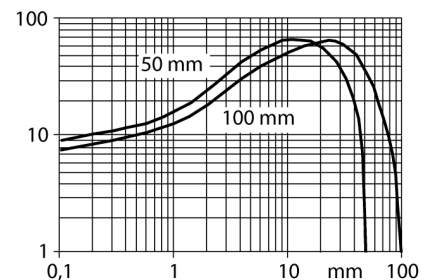

<b>Type code</b>	Q25SN6FF100Q
Ident no.	3031940
<b>Operating mode</b>	diffuse mode sensor with fixed-field background suppression
Light type	IR
Wavelength	880 nm
Range	0...100 mm
Ambient temperature	-40...+70 °C
<b>Operating voltage</b>	10...30VDC
No-load current I <sub>0</sub>	≤ 35 mA
Short-circuit protection	yes/ cyclic
Reverse polarity protection	yes
Output function	connection programmable, NPN
Switching frequency	≤ 160 Hz
Readiness delay	≤ 100 ms
Overcurrent release	> 220 mA
<b>Design</b>	rectangular, Q25
Dimensions	30 x 25 x 62.7 mm
Housing material	plastic, PBT
Lens	plastic, acrylic
Connection	male, M12 x 1
Protection class	IP67 / IP69K
MTTF	448 years acc. to SN 29500 (Ed. 99) 40 °C
<b>Power-on indication</b>	LED green
Switching state	LED yellow
Error indication	LED green flashing
Alarm display	LED yellow flashing

**Photoelectric sensor  
diffuse mode sensor with fixed-field background suppression  
Q25SN6FF100Q**

**Accessories**

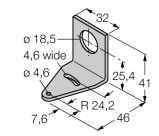
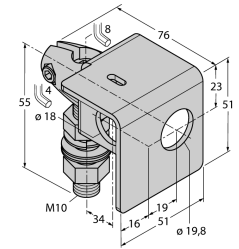
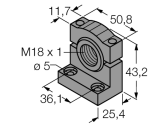
Type code	Ident no.	Description	Dimension drawing
SMB18A	3033200	Mounting bracket, stainless steel, for sensors with 18 mm thread	
SMB18AFAM10	3012558	Mounting bracket, material VA 1.4401, for M10 x 1.5 thread, thread length 18 mm	
SMB18SF	3052519	Mounting bracket, PTB black steel, for sensors with 18 mm thread	

**Wiring accessories**

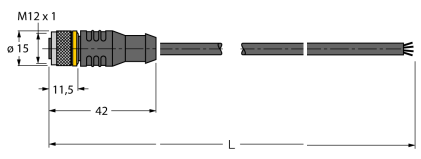
Type code	Ident no.	Description	Dimension drawing
RKC4.4T-2/TEL	6625013	Connection cable, female M12, straight, 4-pin, cable length: 2 m, sheath material: PVC, black; cULus approval; other cable lengths and qualities available, see <a href="http://www.turck.com">www.turck.com</a>	
WKC4.4T-2/TEL	6625025	Connection cable, female M12, angled, 4-pin, cable length: 2 m, sheath material: PVC, black; cULus approval; other cable lengths and qualities available, see <a href="http://www.turck.com">www.turck.com</a>	