

**Photoelectric sensor
diffuse mode sensor with fixed-field background suppression
S30SN6FF400Q**

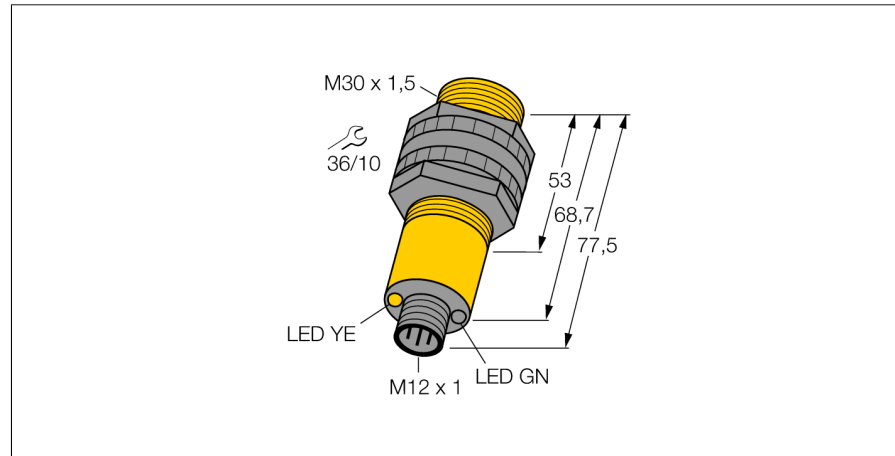

- Male M12 x 1, 5-pin
- Protection classes IP67/IP69K
- Ambient temperature: -40...+70 ° C
- Operating voltage: 10...30 VDC
- NPN switching output, changeover

Wiring diagram

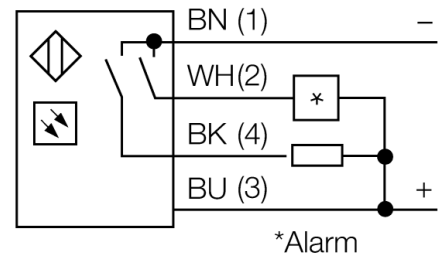
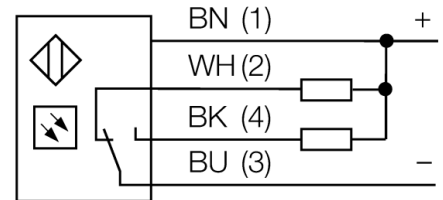

Functional principle

The emitter and receiver are incorporated in a single housing. The light reflection of the target is detected and triggers the sensor to switch. Thus the switching distance largely depends on the reflectivity of the target.

Excess gain curve

Excess gain in relation to the distance

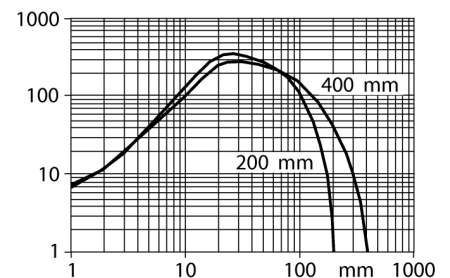

| | |
|--------------------------------|---|
| Type code | S30SN6FF400Q |
| Ident no. | 3033369 |
| Operating mode | diffuse mode sensor with fixed-field background suppression |
| Light type | IR |
| Wavelength | 880 nm |
| Range | 0...400 mm |
| Ambient temperature | -40...+70 °C |
| Operating voltage | 10...30VDC |
| No-load current I ₀ | ≤ 35 mA |
| Short-circuit protection | yes/ cyclic |
| Reverse polarity protection | yes |
| Output function | connection programmable, NPN |
| Switching frequency | ≤ 160 Hz |
| Readiness delay | ≤ 100 ms |
| Overcurrent release | > 220 mA |
| Design | cylindrical/threaded, S30 |
| Dimensions | 77.5 mm |
| Housing diameter | 30 mm |
| Housing material | plastic, PBT |
| Lens | plastic, acrylic |
| Connection | male, M12 x 1 |
| Protection class | IP67 / IP69K |
| MTTF | 448 years acc. to SN 29500 (Ed. 99) 40 °C |
| Power-on indication | LED green |
| Switching state | LED yellow |
| Error indication | LED green flashing |
| Alarm display | LED yellow flashing |

**Photoelectric sensor
diffuse mode sensor with fixed-field background suppression
S30SN6FF400Q**

Accessories

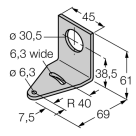
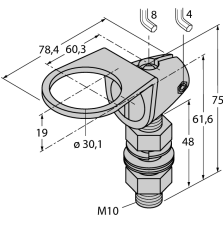
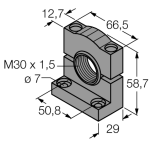
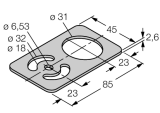
| Type code | Ident no. | Description | Dimension drawing |
|------------|-----------|--|---|
| SMB30A | 3032723 | Mounting bracket, stainless steel, for sensors with 30 mm thread |  |
| SMB30FAM10 | 3011185 | Mounting bracket, stainless steel, for M10 x 1.5 thread, thread length 30 mm |  |
| SMB30SC | 3052521 | Mounting bracket, PBT black; for 30 mm thread; with 4 screws M5 x 0.8 |  |
| SMBAMS30P | 3073135 | Mounting bracket, stainless steel, for sensors with 30 mm thread |  |

Wiring accessories

| Type code | Ident no. | Description | Dimension drawing |
|---------------|-----------|---|---|
| RKC4.4T-2/TEL | 6625013 | Connection cable, female M12, straight, 4-pin, cable length: 2 m, sheath material: PVC, black; cULus approval; other cable lengths and qualities available, see www.turck.com |  |

**Photoelectric sensor
diffuse mode sensor with fixed-field background suppression
S30SN6FF400Q**

Wiring accessories

| Type code | Ident no. | Description | Dimension drawing |
|---------------|-----------|--|---|
| WKC4.4T-2/TEL | 6625025 | Connection cable, female M12, angled, 4-pin, cable length: 2 m, sheath material: PVC, black; cULus approval; other cable lengths and qualities available, see www.turck.com |  |