

Photoelectric sensor
diffuse mode sensor with fixed-field background suppression
TM18AP6FF50Q8

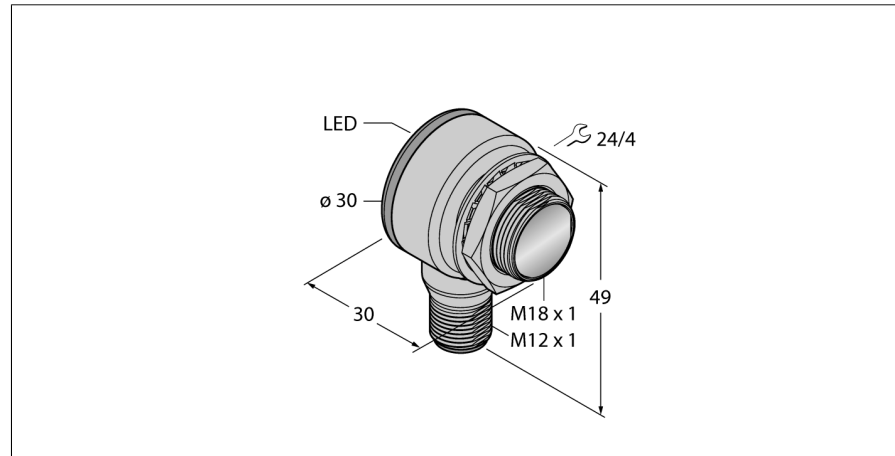

- Male M12 x 1, 5-pin
- Protection classes IP67/IP69K
- Ambient temperature: -40...+70 ° C
- Metal housing
- Operating voltage: 10...30 VDC
- PNP switching output, light operation

Wiring diagram

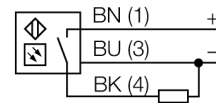

Functional principle

The emitter and receiver are incorporated in a single housing. The light reflection of the target is detected and triggers the sensor to switch. Thus the switching distance largely depends on the reflectivity of the target.

Excess gain curve

Excess gain in relation to the distance

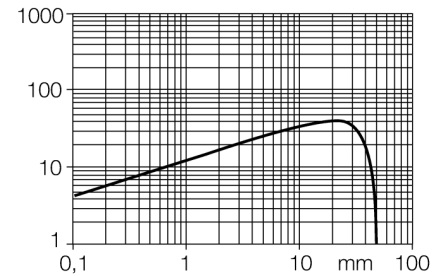

Type code	TM18AP6FF50Q8
Ident no.	3042015
Operating mode	diffuse mode sensor with fixed-field background suppression
Light type	red
Wavelength	660 nm
Range	0...50 mm
Ambient temperature	-40...+70 °C
Operating voltage	10...30VDC
No-load current I ₀	≤ 25 mA
Short-circuit protection	yes/ cyclic
Reverse polarity protection	yes
Output function	NO, light operation, PNP
Switching frequency	≤ 220 Hz
Readiness delay	≤ 100 ms
Design	cylindrical/threaded, TM18
Dimensions	30 x 30 x 49 mm
Housing material	metal/plastic, CuZn
Lens	plastic, acrylic
Connection	male, M12 x 1
Protection class	IP67 / IP69K
MTTF	448 years acc. to SN 29500 (Ed. 99) 40 °C
Power-on indication	LED green
Switching state	LED yellow
Error indication	LED green flashing
Alarm display	LED yellow flashing

**Photoelectric sensor
diffuse mode sensor with fixed-field background suppression
TM18AP6FF50Q8**

Accessories

Type code	Ident no.	Description	Dimension drawing
SMBT18Y	3069554	mounting bracket, rectangular, for sensors with 18 mm thread, 15.3 mm cable feedthrough or M12 x 1 male	
SMB18A	3033200	Mounting bracket, stainless steel, for sensors with 18 mm thread	
SMBAMS18P	3073134	Mounting bracket, stainless steel, for sensors with 18 mm thread	

Wiring accessories

Type code	Ident no.	Description	Dimension drawing
RKC4.4T-2/TEL	6625013	Connection cable, female M12, straight, 4-pin, cable length: 2 m, sheath material: PVC, black; cULus approval; other cable lengths and qualities available, see www.turck.com	
WKC4.4T-2/TEL	6625025	Connection cable, female M12, angled, 4-pin, cable length: 2 m, sheath material: PVC, black; cULus approval; other cable lengths and qualities available, see www.turck.com	