

Photoelectric sensor
diffuse mode sensor with fixed-field background suppression
QMT42VN6FF1000Q

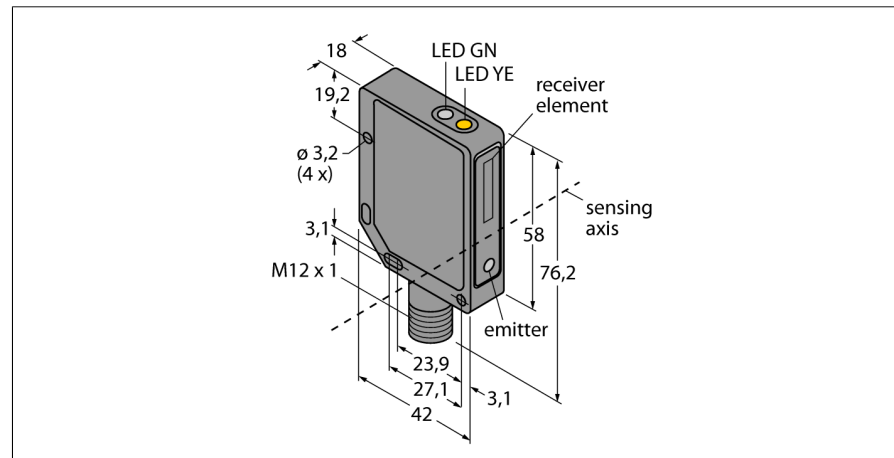

- Male M12 x 1, 4-pin
- Metal housing, ZN, black
- Protection class IP67
- Operating voltage 10...30 VDC
- NPN switching output
- Light/dark operation

Wiring diagram

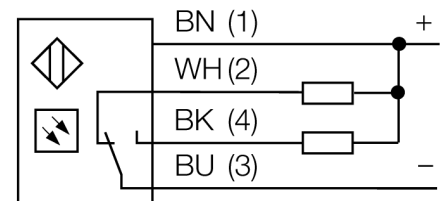

Type code	QMT42VN6FF1000Q
Ident no.	3049232
Operating mode	diffuse mode sensor with fixed-field background suppression
Light type	IR
Wavelength	880 nm
Range	50...1000 mm
Ambient temperature	-20...+55 °C
Operating voltage	10...30VDC
Residual ripple	< 10 % U _s
DC rated operational current	≤ 100 mA
No-load current I ₀	≤ 50 mA
Short-circuit protection	yes
Reverse polarity protection	yes
Output function	NO/NC , NPN
Switching frequency	≤ 500 Hz
Readiness delay	≤ 100 ms
Overcurrent release	> 150 mA
Design	rectangular, QMT42
Dimensions	42 x 18 x 76.2 mm
Housing material	metal, ZN, black lacquer
Lens	plastic, acrylic
Connection	male, M12 x 1
Protection class	IP67
Power-on indication	LED green
Switching state	LED yellow
Error indication	LED green flashing
Alarm display	LED yellow flashing

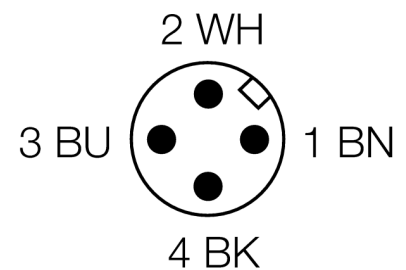

Functional principle

Diffuse mode sensors with background suppression operate with a single emitter and several receiver elements. The target position and the photoelectric structure of the sensor determine which of the receiving elements receives the most light. The sensor electronics determine whether the reflecting object is within or outside the measuring range. These sensors come with a fixed cut-off point.

Excess gain curve

Excess gain in relation to the distance

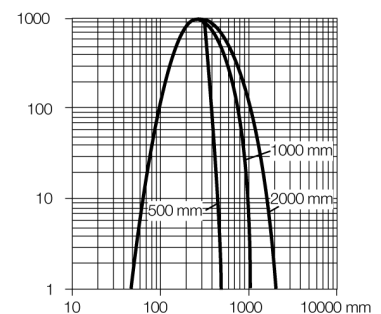

**Photoelectric sensor
diffuse mode sensor with fixed-field background suppression
QMT42VN6FF1000Q**

Accessories

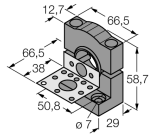
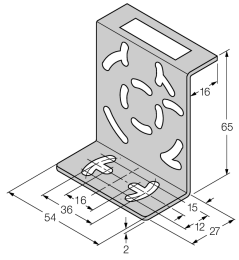
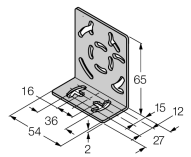
Type code	Ident no.	Description	Dimension drawing
SMB30SK	3052523	Mounting bracket, PBT black, with mounting plate, stainless steel, for types with 18 mm thread, QM42/QMT42	
SMB46S	3048748	Mounting bracket, stainless steel, for QS18, QS30, MINI-BEAM, QM42/QMT42	
SMB46L	3048747	Mounting bracket, stainless steel, for QS18, QS30, MINI-BEAM, QM42/QMT42	

Wiring accessories

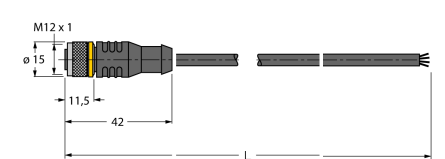
Type code	Ident no.	Description	Dimension drawing
RKC4.4T-2/TEL	6625013	Connection cable, female M12, straight, 4-pin, cable length: 2 m, sheath material: PVC, black; cULus approval; other cable lengths and qualities available, see www.turck.com	
WKC4.4T-2/TEL	6625025	Connection cable, female M12, angled, 4-pin, cable length: 2 m, sheath material: PVC, black; cULus approval; other cable lengths and qualities available, see www.turck.com	