

Photoelectric sensor
diffuse mode sensor with fixed-field background suppression
QS18VP6FF50Q8

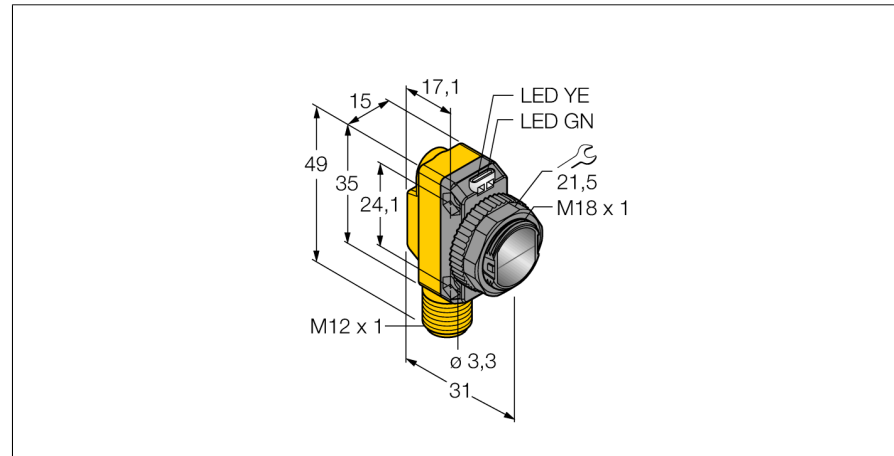

- Male M12 x 1, 4-pin
- Protection class IP67
- LED all-round visible

Wiring diagram

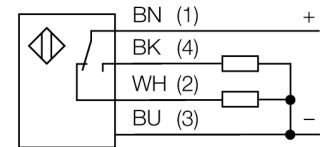

Type code	QS18VP6FF50Q8
Ident no.	3071755
Operating mode	diffuse mode sensor with fixed-field background suppression
Light type	red
Wavelength	660 nm
Range	0...50 mm
Ambient temperature	-20...+70 °C
Operating voltage	10...30VDC
Residual ripple	< 10 % U _s
DC rated operational current	≤ 100 mA
Short-circuit protection	yes
Reverse polarity protection	yes
Output function	NO/NC , PNP
Switching frequency	≤ 625 Hz
Readiness delay	≤ 100 ms
Design	rectangular, QS18
Dimensions	31 x 15 x 35 mm
Housing material	plastic, ABS
Lens	plastic, acrylic
Connection	male, M12 x 1
Protection class	IP67
MTTF	965 years acc. to SN 29500 (Ed. 99) 40 °C
Power-on indication	LED green
Switching state	LED yellow
Error indication	LED green flashing
Excess gain indication	LED yellow flashing

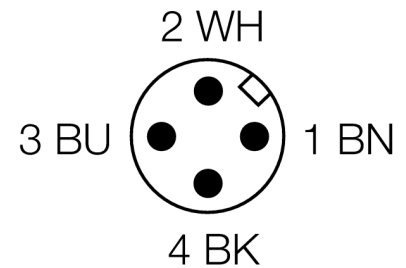

Functional principle

Diffuse mode sensors with background suppression operate with a single emitter and several receiver elements. The target position and the photoelectric structure of the sensor determine which of the receiving elements receives the most light. The sensor electronics determine whether the reflecting object is within or outside the measuring range. These sensors come with a fixed cut-off point.

Excess gain curve

Excess gain in relation to the distance

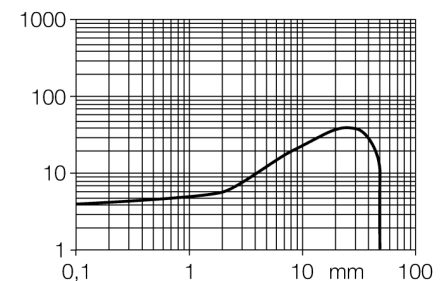

**Photoelectric sensor
diffuse mode sensor with fixed-field background suppression
QS18VP6FF50Q8**

Accessories

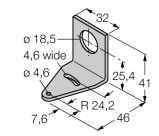
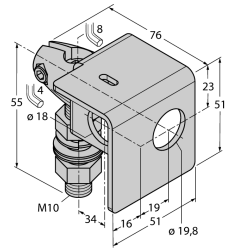
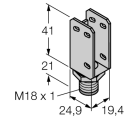
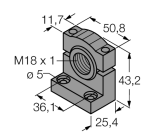
Type code	Ident no.	Description	Dimension drawing
SMB18A	3033200	Mounting bracket, stainless steel, for sensors with 18 mm thread	
SMB18AFAM10	3012558	Mounting bracket, material VA 1.4401, for M10 x 1.5 thread, thread length 18 mm	
SMBQS18A	3069721	Mounting bracket, stainless steel, for 18 mm thread	
SMB18SF	3052519	Mounting bracket, PTB black steel, for sensors with 18 mm thread	

Wiring accessories

Type code	Ident no.	Description	Dimension drawing
RKC4.4T-2/TEL	6625013	Connection cable, female M12, straight, 4-pin, cable length: 2 m, sheath material: PVC, black; cULus approval; other cable lengths and qualities available, see www.turck.com	

**Photoelectric sensor
diffuse mode sensor with fixed-field background suppression
QS18VP6FF50Q8**

Wiring accessories

Type code	Ident no.	Description	Dimension drawing
WKC4.4T-2/TEL	6625025	Connection cable, female M12, angled, 4-pin, cable length: 2 m, sheath material: PVC, black; cULus approval; other cable lengths and qualities available, see www.turck.com	