

**Photoelectric sensor**  
**diffuse mode sensor with fixed-field background suppression**  
**miniature sensor**  
**Q12AB6FF15Q**

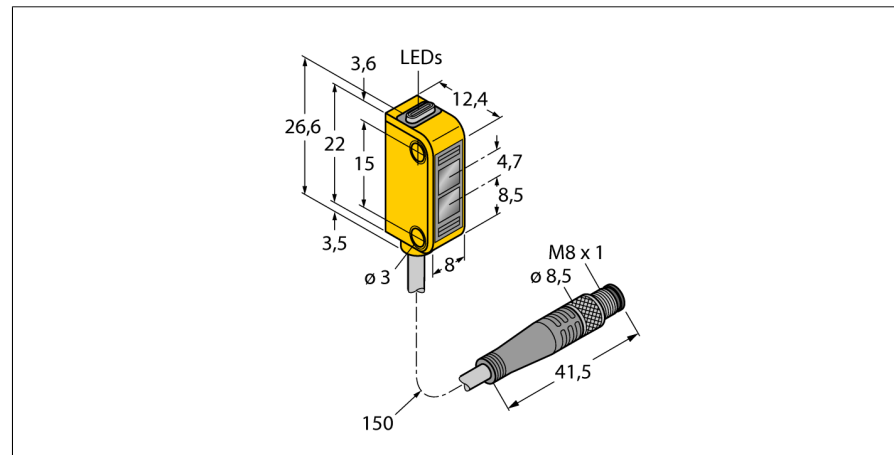

- Cable with male end, 4-pin, PVC, 150 mm, 8 mm
- Protection class IP67
- LED all-round visible
- Indication of insufficient excess gain
- Operating voltage: 10...30 VDC
- Switching output, bipolar, light operation

**Wiring diagram**

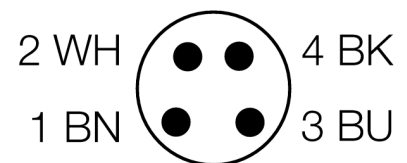

<b>Type code</b>	Q12AB6FF15Q
Ident no.	3072105
<b>Operating mode</b>	diffuse mode sensor with fixed-field background suppression
Light type	red
Wavelength	640 nm
Range	3...15 mm
Ambient temperature	-20...+55 °C
<b>Operating voltage</b>	10...30VDC
Residual ripple	< 10 % U <sub>s</sub>
DC rated operational current	≤ 50 mA
No-load current I <sub>0</sub>	≤ 20 mA
Short-circuit protection	yes
Reverse polarity protection	yes
Output function	NO, light operation, PNP/NPN
Switching frequency	≤ 700 Hz
Readiness delay	≤ 120 ms
<b>Design</b>	rectangular, Q12
Dimensions	12.4 x 8 x 26.6 mm
Housing material	plastic, Elastomere, yellow
Lens	plastic, polycarbonate
Connection	cable with connector, PVC, M8 x 1
Cable length	0.15 m
Cable cross section	4 x 0.34 mm <sup>2</sup>
Protection class	IP67
MTTF	135 years acc. to SN 29500 (Ed. 99) 40 °C
<b>Power-on indication</b>	LED green
Switching state	LED yellow
Error indication	LED green
Excess gain indication	LED yellow flashing

**Functional principle**

The emitter and receiver are incorporated in a single housing. The light reflection of the target is detected and triggers the sensor to switch. Thus the switching distance largely depends on the reflectivity of the target.

**Excess gain curve**

Excess gain in relation to the distance

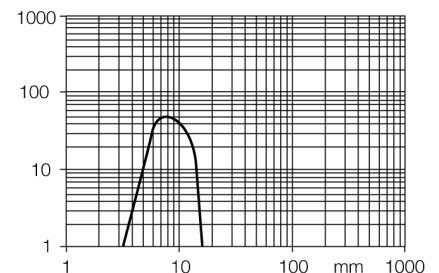

**Photoelectric sensor  
diffuse mode sensor with fixed-field background suppression  
miniature sensor  
Q12AB6FF15Q**

**Accessories**

Type code	Ident no.	Description	Dimension drawing
SMBQ12A	3074341	Mounting bracket; material VA 1.4401, for photoelectric sensor, Q12 series	
SMBQ12T	3073722	Mounting bracket; material VA 1.4401, for photoelectric sensor, Q12 series	

**Wiring accessories**

Type code	Ident no.	Description	Dimension drawing
PKG4M-2/TEL	6625061	Connection cable, female M8, straight, 4-pin, cable length: 2 m, sheath material: PVC, black; cULus approval; other cable lengths and qualities available, see <a href="http://www.turck.com">www.turck.com</a>	
PKW4M-2/TEL	6625067	Connection cable, female M8, angled, 4-pin, cable length: 2 m, sheath material: PVC, black; cULus approval; other cable lengths and qualities available, see <a href="http://www.turck.com">www.turck.com</a>	