

Photoelectric sensor
diffuse mode sensor with fixed-field background suppression
miniature sensor
Q12RB6FF30Q

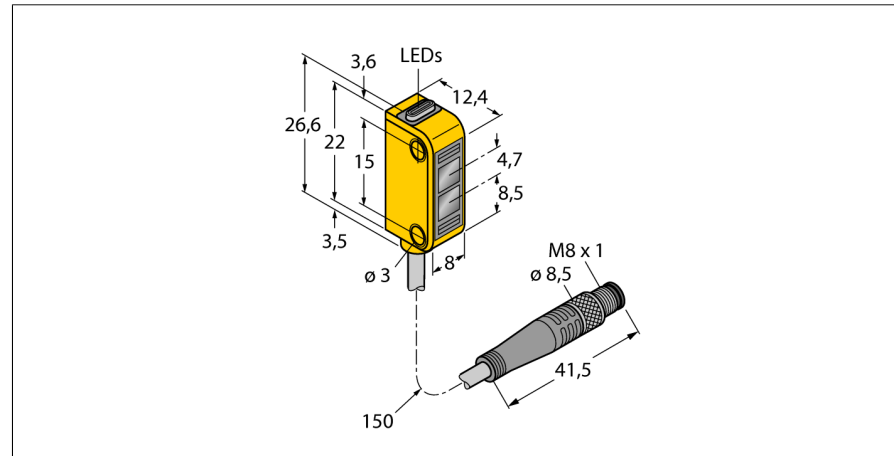

- Cable with male end, 4-pin, PVC, 150 mm, 8 mm
- Protection class IP67
- LED all-round visible
- Indication of insufficient excess gain
- Operating voltage: 10...30 VDC
- Switching output, bipolar, dark operation

Wiring diagram



Type code	Q12RB6FF30Q
Ident no.	3072114
Operating mode	diffuse mode sensor with fixed-field background suppression
Light type	red
Wavelength	640 nm
Range	3...30 mm
Ambient temperature	-20...+55 °C
Operating voltage	10...30VDC
Residual ripple	< 10 % U _s
DC rated operational current	≤ 50 mA
No-load current I ₀	≤ 20 mA
Short-circuit protection	yes
Reverse polarity protection	yes
Output function	NO, dark operation, PNP/NPN
Switching frequency	≤ 700 Hz
Readiness delay	≤ 120 ms
Design	rectangular, Q12
Dimensions	12.4 x 8 x 26.6 mm
Housing material	plastic, Elastomere, yellow
Lens	plastic, polycarbonate
Connection	cable with connector, PVC, M8 x 1
Cable length	0.15 m
Cable cross section	4 x 0.34 mm ²
Protection class	IP67
MTTF	135 years acc. to SN 29500 (Ed. 99) 40 °C
Power-on indication	LED green
Switching state	LED yellow
Error indication	LED green
Excess gain indication	LED yellow flashing

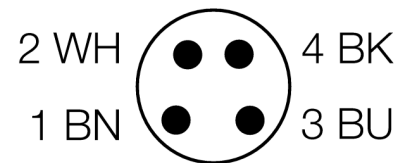

Functional principle

The emitter and receiver are incorporated in a single housing. The light reflection of the target is detected and triggers the sensor to switch. Thus the switching distance largely depends on the reflectivity of the target.

Excess gain curve

Excess gain in relation to the distance

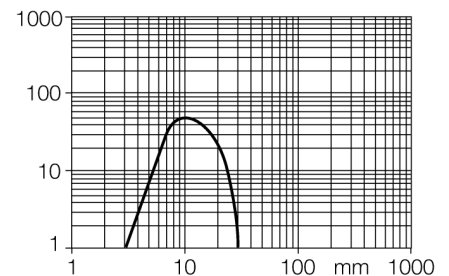

**Photoelectric sensor
diffuse mode sensor with fixed-field background suppression
miniature sensor
Q12RB6FF30Q**

Accessories

Type code	Ident no.	Description	Dimension drawing
SMBQ12A	3074341	Mounting bracket; material VA 1.4401, for photoelectric sensor, Q12 series	
SMBQ12T	3073722	Mounting bracket; material VA 1.4401, for photoelectric sensor, Q12 series	

Wiring accessories

Type code	Ident no.	Description	Dimension drawing
PKG4M-2/TEL	6625061	Connection cable, female M8, straight, 4-pin, cable length: 2 m, sheath material: PVC, black; cULus approval; other cable lengths and qualities available, see www.turck.com	
PKW4M-2/TEL	6625067	Connection cable, female M8, angled, 4-pin, cable length: 2 m, sheath material: PVC, black; cULus approval; other cable lengths and qualities available, see www.turck.com	