

Photoelectric sensor
diffuse mode sensor with fixed-field background suppression
QS30FF400

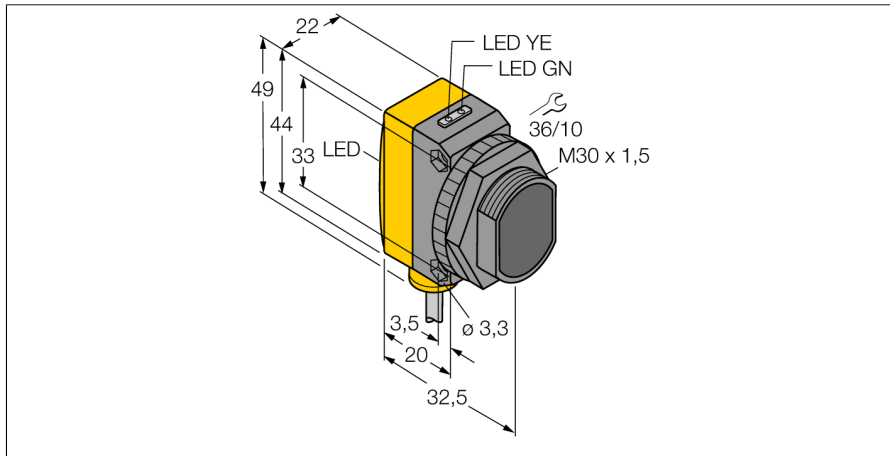

- Cable, PVC, 2 m
- Protection class IP67
- LED all-round visible
- Operating voltage: 10...30 VDC
- Switching output, bipolar
- Light or dark operation

Wiring diagram

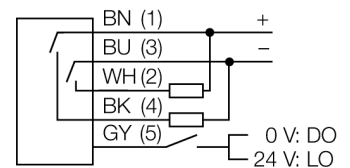

Functional principle

Diffuse mode sensors with background suppression operate with a single emitter and several receiver elements. The target position and the photoelectric structure of the sensor determine which of the receiving elements receives the most light. The sensor electronics determine whether the reflecting object is within or outside the measuring range. These sensors come with a fixed cut-off point.

Excess gain curve

Excess gain in relation to the distance

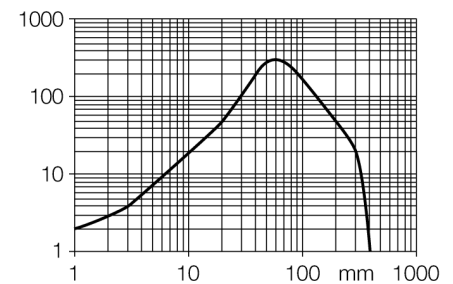

Type code	QS30FF400
Ident no.	3073088
Operating mode	diffuse mode sensor with fixed-field background suppression
Light type	red
Wavelength	680 nm
Range	0...400 mm
Ambient temperature	-20...+70 °C
Operating voltage	10...30VDC
Residual ripple	< 10 % U _s
DC rated operational current	≤ 150 mA
No-load current I ₀	≤ 35 mA
Short-circuit protection	yes
Reverse polarity protection	yes
Output function	NO contact, PNP/NPN
Switching frequency	≤ 250 Hz
Readiness delay	≤ 100 ms
Design	rectangular, QS30
Dimensions	35 x 22 x 49 mm
Housing material	plastic, ABS, yellow
Lens	plastic, acrylic
Connection	cable, PVC
Cable length	2 m
Cable cross section	5 x 0.5 mm ²
Protection class	IP67
MTTF	177 years acc. to SN 29500 (Ed. 99) 40 °C
Power-on indication	LED green
Switching state	LED yellow
Error indication	LED green flashing
Excess gain indication	LED yellow

**Photoelectric sensor
diffuse mode sensor with fixed-field background suppression
QS30FF400**

Accessories

Type code	Ident no.	Description	Dimension drawing
SMB30A	3032723	Mounting bracket, stainless steel, for sensors with 30 mm thread	
SMBQS30L	3002809	Mounting bracket, stainless steel, for QS30 series	
SMBQS30Y	3002811	Protective housing, stainless steel, for QS30 series	
SMBQS30YL	3072741	Protective housing with safety glass panel, stainless steel, for QS30 series	