

Photoelectric sensor
diffuse mode sensor with fixed-field background suppression
Q20PFF150Q7

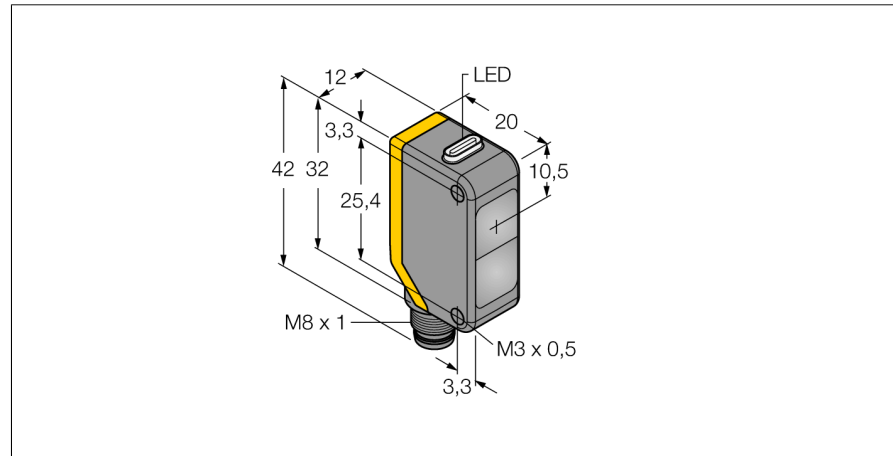

- Male M8 x 1; 4-pin
- Protection class IP67
- LED all-round visible
- Operating voltage: 10...30 VDC
- PNP switching output, changeover

Wiring diagram

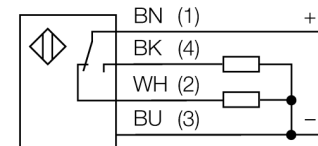

Functional principle

Diffuse mode sensors with background suppression operate with a single emitter and several receiver elements. The target position and the photoelectric structure of the sensor determine which receiver element gets the most light. The sensor electronics determine whether the reflecting object is within or outside the measuring range. These sensors come with a fixed cut-off point.

Excess gain curve

Excess gain in relation to the distance

Excess gain curve

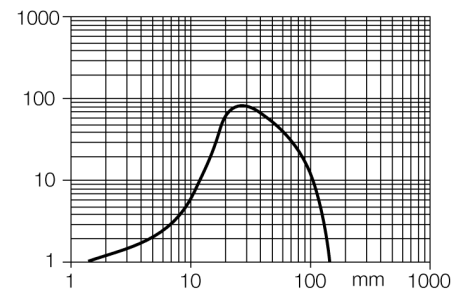

Type code	Q20PFF150Q7
Ident no.	3078156
Operating mode	diffuse mode sensor with fixed-field background suppression
Light type	red
Wavelength	660 nm
Range	0...150 mm
Ambient temperature	-20...+60 °C
Operating voltage	10...30VDC
Residual ripple	< 10 % U _s
DC rated operational current	≤ 100 mA
No-load current I ₀	≤ 18 mA
Reverse polarity protection	yes
Output function	changover contact, PNP
Switching frequency	≤ 600 Hz
Readiness delay	≤ 100 ms
Design	rectangular, Q20
Dimensions	20 x 12 x 42 mm
Housing material	plastic, ABS
Lens	plastic, acrylic
Connection	male, M8 x 1
Protection class	IP67
Power-on indication	LED green
Switching state	LED yellow
Error indication	LED green flashing
Excess gain indication	LED yellow flashing

**Photoelectric sensor
diffuse mode sensor with fixed-field background suppression
Q20PFF150Q7**

Accessories

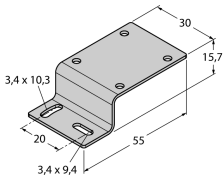
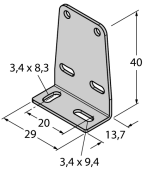
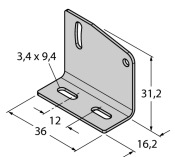
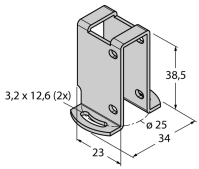
Type code	Ident no.	Description	Dimension drawing
SMBQ20H	3079041	Mounting bracket, stainless steel, horizontally mounted, for Q20	
SMBQ20L	3079040	Mounting bracket, stainless steel, rectangular, for Q20	
SMBQ20LV	3079042	Mounting bracket, stainless steel, rectangular, for Q20	
SMBQ20U	3079043	Protective housing, stainless steel, for Q20	

Wiring accessories

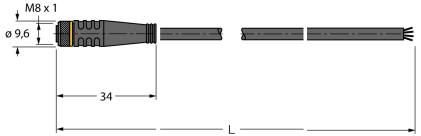
Type code	Ident no.	Description	Dimension drawing
PKG4M-2/TEL	6625061	Connection cable, female M8, straight, 4-pin, cable length: 2 m, sheath material: PVC, black; cULus approval; other cable lengths and qualities available, see www.turck.com	

**Photoelectric sensor
diffuse mode sensor with fixed-field background suppression
Q20PFF150Q7**

Wiring accessories

Type code	Ident no.	Description	Dimension drawing
PKW4M-2/TEL	6625067	Connection cable, female M8, angled, 4-pin, cable length: 2 m, sheath material: PVC, black; cULus approval; other cable lengths and qualities available, see www.turck.com	
PKG4S-2/TEL	6627370	Connection cable, female Ø 8 mm, straight, 4-pin, snap-on type, cable length: 2 m; sheath material: PVC, sheath color: black, cULus approved, RoHS conform, protection class IP67	
PKW4S-2/TEL	6627373	Connection cable, female Ø 8 mm, straight, 4-pin, snap-on type, cable length: 2 m; sheath material: PVC, sheath color: black, cULus approved, RoHS conform, protection class IP67	