

Photoelectric sensor
diffuse mode sensor with fixed-field background suppression
M12PFF75Q8

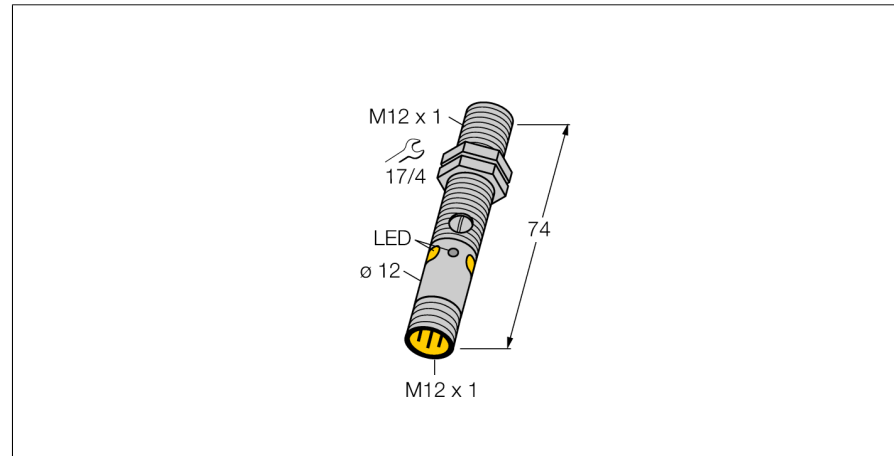

- Male M12 x 1, 4-pin
- Protection classes IP67 / IP68
- Metal housing
- LED all-round visible
- Indication of insufficient excess gain
- Operating voltage: 10...30 VDC
- PNP switching output, changeover

Wiring diagram

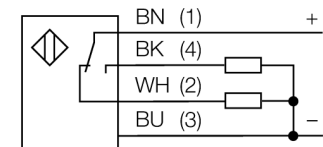

Functional principle

Diffuse mode sensors with background suppression operate with a single emitter and several receiver elements. The target position and the photoelectric structure of the sensor determine which of the receiving elements receives the most light. The sensor electronics determine whether the reflecting object is within or outside the measuring range. These sensors come with a fixed cut-off point.

Excess gain curve

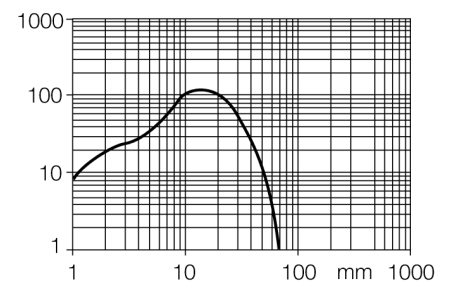

Type code	M12PFF75Q8
Ident no.	3078229
Operating mode	diffuse mode sensor with fixed-field background suppression
Light type	red
Wavelength	680 nm
Range	0...75 mm
Ambient temperature	-20...+60 °C
Operating voltage	10...30VDC
Residual ripple	< 10 % U _s
DC rated operational current	≤ 100 mA
No-load current I ₀	≤ 20 mA
Short-circuit protection	yes
Reverse polarity protection	yes
Output function	changeover contact, PNP
Switching frequency	≤ 1000 Hz
Readiness delay	≤ 100 ms
Design	threaded barrel, M12
Dimensions	74 mm
Housing diameter	12 mm
Housing material	metal, CuZn, nickel-plated
Lens	plastic, PMMP
Connection	male, M12 x 1
Protection class	IP68
MTTF	46 years acc. to SN 29500 (Ed. 99) 40 °C
Power-on indication	LED green
Switching state	LED yellow
Error indication	LED green flashing
Excess gain indication	LED yellow flashing

**Photoelectric sensor
diffuse mode sensor with fixed-field background suppression
M12PFF75Q8**

Accessories

Type code	Ident no.	Description	Dimension drawing
SMB12FAM10	3011221	Mounting bracket, stainless steel, for M12, M10 x 1.5 thread	
SMB12MM	3027635	Mounting bracket, stainless steel, for M12	
SMBQS12PD	3059606	Mounting bracket; material VA 1.4401, for Q12 & M12 series	

Wiring accessories

Type code	Ident no.	Description	Dimension drawing
RKC4.4T-2/TEL	6625013	Connection cable, female M12, straight, 4-pin, cable length: 2 m, sheath material: PVC, black; cULus approval; other cable lengths and qualities available, see www.turck.com	
WKC4.4T-2/TEL	6625025	Connection cable, female M12, angled, 4-pin, cable length: 2 m, sheath material: PVC, black; cULus approval; other cable lengths and qualities available, see www.turck.com	