

**Photoelectric sensor
base unit for plastic fibers
QM42VP6FPQ**

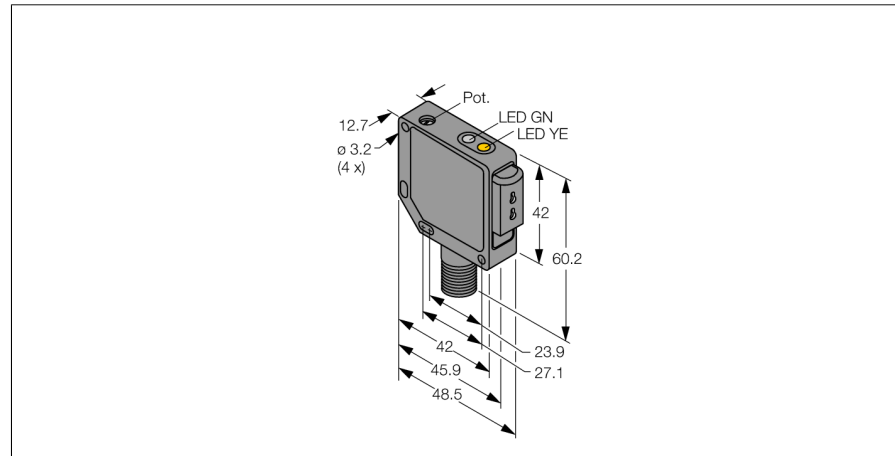

- Male M12 x 1, 4-pin
- Metal housing, ZN, black
- Protection class IP67
- Sensitivity adjusted via potentiometer
- Operating voltage 10...30 VDC
- PNP switching output
- Light/dark operation

Wiring diagram

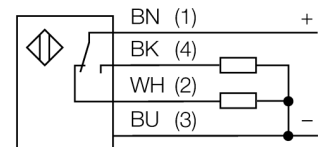

Type code	QM42VP6FPQ
Ident no.	3045784
Operating mode	fibre optic sensor
Light type	red
Wavelength	660 nm
Ambient temperature	-20...+70 °C
Operating voltage	10...30VDC
Residual ripple	< 10 % U _s
DC rated operational current	≤ 100 mA
No-load current I ₀	≤ 30 mA
Short-circuit protection	yes
Reverse polarity protection	yes
Output function	NO/NC , PNP
Readiness delay	≤ 100 ms
Overcurrent release	> 150 mA
Design	rectangular, QM42
Dimensions	48.5 x 12.7 x 60.2 mm
Housing material	metal, ZN, black lacquer
Connection	male, M12 x 1
Protection class	IP67
Power-on indication	LED green
Switching state	LED yellow
Error indication	LED green flashing
Alarm display	LED yellow flashing

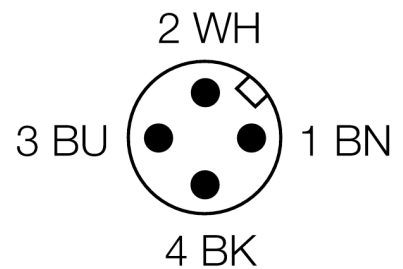

Functional principle

Glass or fibre optic sensors are the optimum choice for high temperature or space restricted applications. Fibre optics transfer the light from the sensor to a remote object. Individual fibre optics are used for opposed mode sensing, whereas bifurcated fibre optics are suited for diffuse mode operation.

Excess gain curve

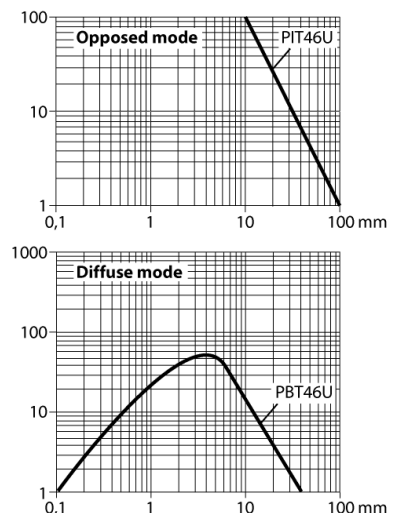

**Photoelectric sensor
base unit for plastic fibers
QM42VP6FPQ**

Accessories

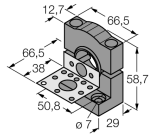
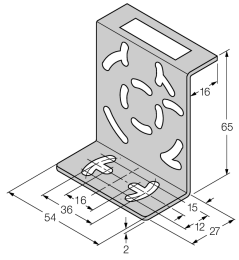
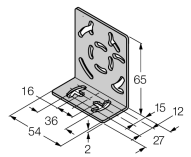
Type code	Ident no.	Description	Dimension drawing
SMB30SK	3052523	Mounting bracket, PBT black, with mounting plate, stainless steel, for types with 18 mm thread, QM42/QMT42	
SMB46S	3048748	Mounting bracket, stainless steel, for QS18, QS30, MI-NI-BEAM, QM42/QMT42	
SMB46L	3048747	Mounting bracket, stainless steel, for QS18, QS30, MI-NI-BEAM, QM42/QMT42	

Wiring accessories

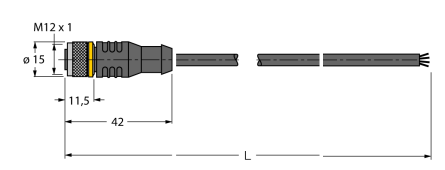
Type code	Ident no.	Description	Dimension drawing
RKC4.4T-2/TEL	6625013	Connection cable, female M12, straight, 4-pin, cable length: 2 m, sheath material: PVC, black; cULus approval; other cable lengths and qualities available, see www.turck.com	
WKC4.4T-2/TEL	6625025	Connection cable, female M12, angled, 4-pin, cable length: 2 m, sheath material: PVC, black; cULus approval; other cable lengths and qualities available, see www.turck.com	