

**Photoelectric sensor
opposed mode sensor (receiver)
receiver
LX3R**

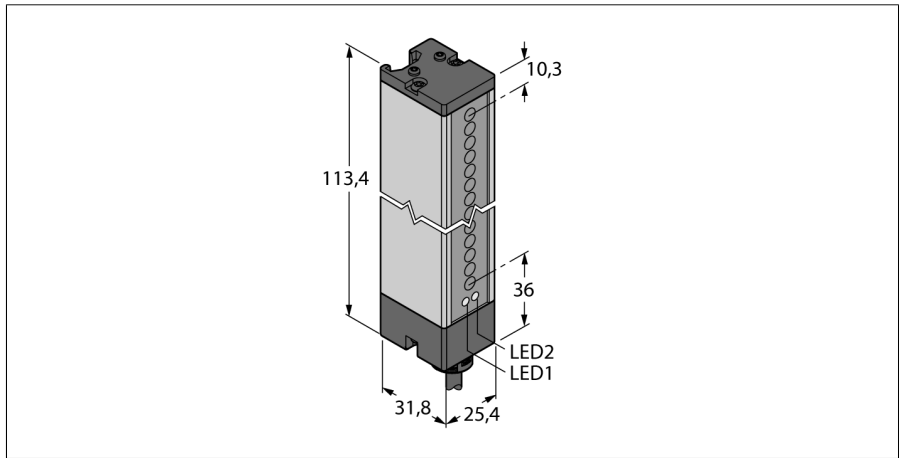

- Cable, 2 m, 5-wire
- Protection class IP65
- Scan field 67 mm
- Minimum target size 9.5 mm
- Operating voltage: 10...30 VDC
- Programmable connection for reduced sensing range

Wiring diagram

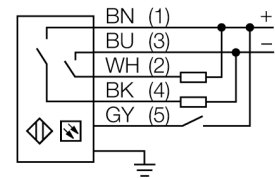

Functional principle

Light screens are especially suited to monitor large areas. They consist of an emitter and a receiver unit. Switching light screens are available with scanning heights of up to 599 mm.

Type code	LX3R
Ident no.	3002664
Operating mode	light screen
Optical resolution	9.5 mm
Range	150...2000 mm
Detection zone height	67 mm
Ambient temperature	-20...+70 °C
Operating voltage	10...30VDC
Residual ripple	< 10 % U _s
No-load current I ₀	≤ 100 mA
Short-circuit protection	yes
Reverse polarity protection	yes
Output function	NO contact, PNP/NPN
Response time	< 0.8 ms
Design	rectangular, LX
Dimensions	31.8 x 25.4 x 113.4 mm
Housing material	metal, AL, grey
Lens	plastic, acrylic
Connection	cable, PVC
Cable length	2 m
Cable cross section	5 x 0.5 mm ²
Protection class	IP65
MTTF	74 years acc. to SN 29500 (Ed. 99) 40 °C
Power-on indication	LED green
Switching state	LED yellow
Error indication	LED red flashing

**Photoelectric sensor
opposed mode sensor (receiver)
receiver
LX3R**

Accessories

Type code	Ident no.	Description	Dimension drawing
SMBLX	3002915	Mounting bracket, galvanized steel, for LX series, 2 pcs., not included in delivery	
SMBLXR	3002914	Foot, galvanized steel, for LX series	