

**Photoelectric sensor  
opposed mode sensor (receiver)  
receiver  
LX3RQ**

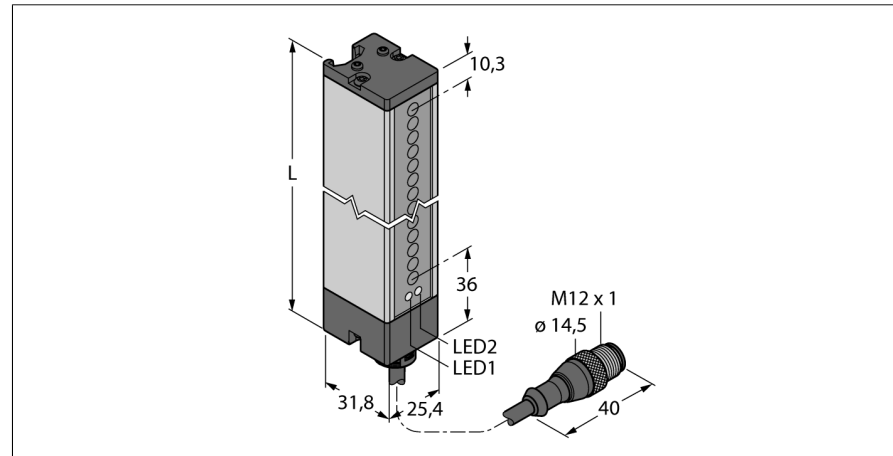

- Cable with male end M12 x 1, 5-pin, 0.15 m
- Protection class IP65
- Scan field 67 mm
- Minimum target size 9.5 mm
- Operating voltage: 10...30 VDC
- Programmable connection for reduced sensing range

**Wiring diagram**

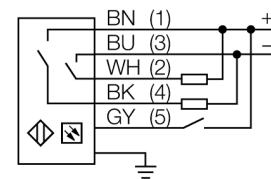

**Functional principle**

Light screens are especially suited to monitor large areas. They consist of an emitter and a receiver unit. Switching light screens are available with scanning heights of up to 599 mm.

<b>Type code</b>	LX3RQ
Ident no.	3002667
<b>Operating mode</b>	light screen
Optical resolution	9.5 mm
Range	150...2000 mm
Detection zone height	67 mm
Ambient temperature	-20...+70 °C
<b>Operating voltage</b>	10...30VDC
Residual ripple	< 10 % U <sub>ss</sub>
No-load current I <sub>0</sub>	≤ 100 mA
Short-circuit protection	yes
Reverse polarity protection	yes
Output function	NO contact, PNP/NPN
Response time	< 0.8 ms
<b>Design</b>	rectangular, LX
Dimensions	31.8 x 25.4 x 113.4 mm
Housing material	metal, AL, grey
Lens	plastic, acrylic
Connection	cable with connector, PVC, M12 x 1
Cable length	0.15 m
Cable cross section	5 x 0.5 mm <sup>2</sup>
Protection class	IP65
MTTF	74 years acc. to SN 29500 (Ed. 99) 40 °C
<b>Power-on indication</b>	LED green
Switching state	LED yellow
Error indication	LED red flashing

**Photoelectric sensor  
opposed mode sensor (receiver)  
receiver  
LX3RQ**

**Accessories**

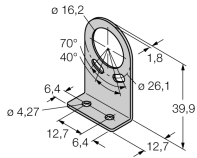
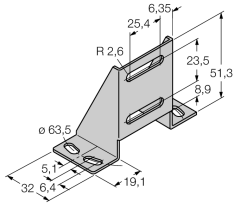
Type code	Ident no.	Description	Dimension drawing
SMBLX	3002915	Mounting bracket, galvanized steel, for LX series, 2 pcs., not included in delivery	 
SMBLXR	3002914	Foot, galvanized steel, for LX series	

**Wiring accessories**

Type code	Ident no.	Description	Dimension drawing
MQDEC2-506	3060810	Anschlusskabel, PVC, geschirmt, Länge 1.83 m, M12 x 1 Kupplung 5-polig auf offenes Ende	
MQDEC2-506RA	3060813	Anschlusskabel, PVC, geschirmt, Länge 1.83 m, M12 x 1 Kupplung gewinkelt 5-polig auf offenes Ende	