

**Photoelectric sensor  
opposed mode sensor (emitter)  
emitter  
LX6ESR**

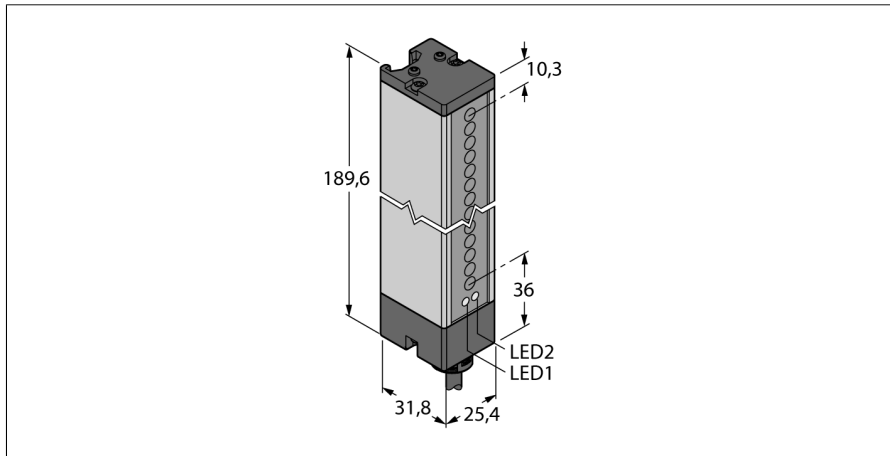

- Cable, 2 m, 5-wire
- Protection class IP65
- Scan field 143 mm
- Minimum target size 5.6 mm
- Operating voltage: 10...30 VDC
- Programmable connection for reduced sensing range

**Wiring diagram**

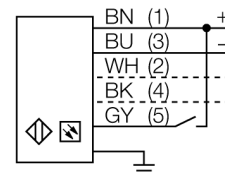

**Functional principle**

Light screens are especially suited to monitor large areas. They consist of an emitter and a receiver unit. Switching light screens are available with scanning heights of up to 599 mm.

<b>Type code</b>	LX6ESR
Ident no.	3002671
<b>Operating mode</b>	light screen
Light type	IR
Wavelength	880 nm
Optical resolution	5.6 mm
Range	75...200 mm
Detection zone height	143 mm
Ambient temperature	-20...+70 °C
<b>Operating voltage</b>	10...30VDC
Residual ripple	< 10 % U <sub>s</sub>
No-load current I <sub>0</sub>	≤ 100 mA
Short-circuit protection	yes
Reverse polarity protection	yes
<b>Design</b>	rectangular, LX
Dimensions	31.8 x 25.4 x 189.6 mm
Housing material	metal, AL, grey
Lens	plastic, acrylic
Connection	cable, PVC
Cable length	2 m
Cable cross section	5 x 0.5 mm <sup>2</sup>
Protection class	IP65
MTTF	74 years acc. to SN 29500 (Ed. 99) 40 °C
<b>Power-on indication</b>	LED green
Error indication	LED red flashing

**Photoelectric sensor  
opposed mode sensor (emitter)  
emitter  
LX6ESR**

**Accessories**

Type code	Ident no.	Description	Dimension drawing
SMBLX	3002915	Mounting bracket, galvanized steel, for LX series, 2 pcs., not included in delivery	
SMBLXR	3002914	Foot, galvanized steel, for LX series	