

**measuring light screen
receiver
EA5R600XKQ**

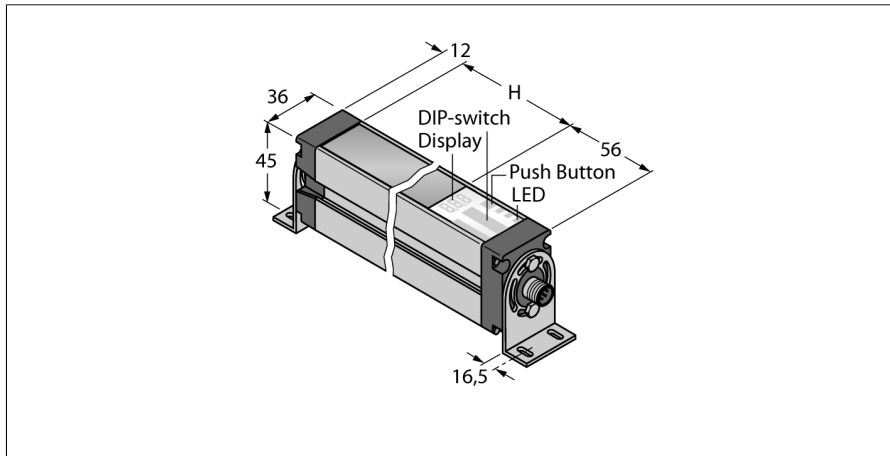

- Male M12 x 1, 8-pin
- Protection class IP65
- Resolution 5 mm
- Max. range 4 m
- Operating voltage 18...30 VDC
- IO-Link communication and PNP switching output (standard via IO-Link splitter CSB-M1240M1280 included in scope of delivery) or analog output 0...10 V via splitter CSB-M1250M1280 (to be ordered separately)
- Extension cable required between emitter and splitter, type DEE2R-8xxD
- 2x PNP switching output (SIO mode)
- 2 x analog outputs 0...10 V (SIO mode)
- Mounting bracket EZA-MBK-11 (for all types) and EZA-MBK-12 (only for ranges ≥ 1050 mm) incl. in delivery

Type code	EA5R600XKQ
Ident no.	3015156
Operating mode	light screen
Optical resolution	5 mm
Range	400...4000 mm
Detection zone height	600 mm
Ambient temperature	-40...+70 °C
Operating voltage	18...30VDC
DC rated operational current	≤ 375 mA
No-load current I ₀	≤ 400 mA
Output function	2x NO, PNP/analog output
Voltage output	0...10V
Load resistance	≥ 2000 Ω
Readiness delay	≤ 2 s
Response time	< 9.3 ms
Design	rectangular, EZ-Array
Dimensions	45.2 x 36 x 678 mm
Housing material	metal, AL, anodized
Lens	plastic, acrylic
Connection	male, M12 x 1
Protection class	IP65
Power-on indication	LED red
Error indication	LED red (2-color LED)
Excess gain indication	LED red

Wiring diagram

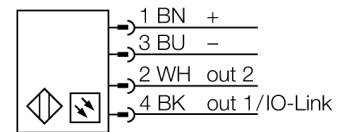

Functional principle

The measuring light screen EZ-Array is ideal for sizing and product profiling, edge and centre guiding, sag and hole detection as well as parts counting. The two-part light screen is easily installed. The electronics is incorporated in the receiver housing and can be configured via 6 DIP switches. For special functions, the screen can be adjusted via PC with the enclosed software. To synchronize emitter and receiver just interconnect the sync-outputs of both.

measuring light screen
receiver
EA5R600XKQ

Accessories

Type code	Ident no.	Description	Dimension drawing
EZA-MBK-11	3071470	Mounting bracket, steel, black-finished, for EZ-ARRAY and EZ-SCREEN standard and cascade 14 & 30 mm	
EZA-MBK-12	3071756	Mounting bracket, steel, black-finished, for EZ-ARRAY and EZ-SCREEN standard and cascade 14 & 30 mm	
EZA-MBK-20	3072587	Mounting bracket, steel, black-finished, for EZ-ARRAY and EZ-SCREEN standard 14 & 30 mm	

Wiring accessories

Type code	Ident no.	Description	Dimension drawing
CSB-M1250M1280	3013879	Y-piece, PVC, black, female 2 x M12 x 1, 8-pin, male 1 x M12 x 5-pin	
DEE2R-88D	3072635	Connection cable, PVC, yellow, length: 2.44 m, female M12 x 1 - male M12, 8-pin	

Function accessories

Type code	Ident no.	Description	Dimension drawing
USB-2-IOL-0002	6825482	IO-Link master with integrated USB port	